



**MAY**  
**21-24**  
**2023**

# CUTTING EDGE METHODS FOR PESTICIDE RESIDUE ANALYSIS AND THE NEW EU GREEN DEAL

**Amadeo R. Fernández-Alba**



**24 May 2023**



## OUTLINE

### -Advances in MRMs related with QqQ-MS/MS analysis

- Sensitivity

- Additional relevant innovations

### -Advances in MRMs related with HRMS análisis

- Sensitivity

- Acquisition modes based on TOF and Orbitrap

- Ion mobility



# Triple quadrupole

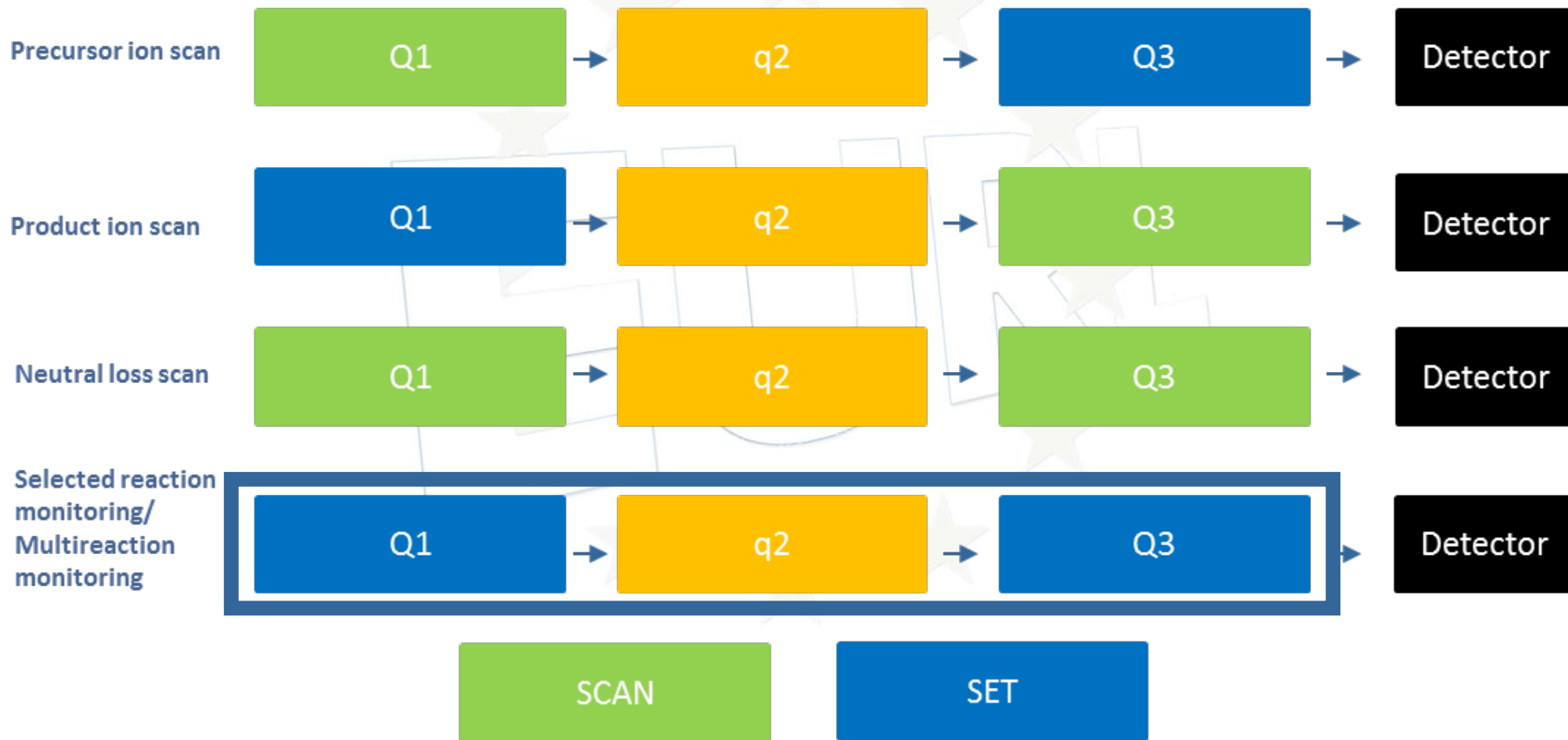

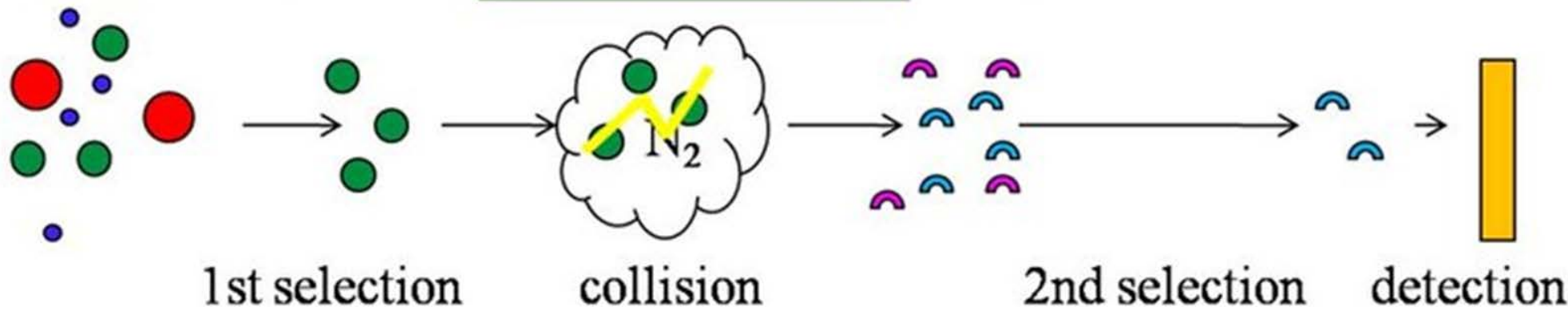

1 Da

## Resolving Power of a quadrupole

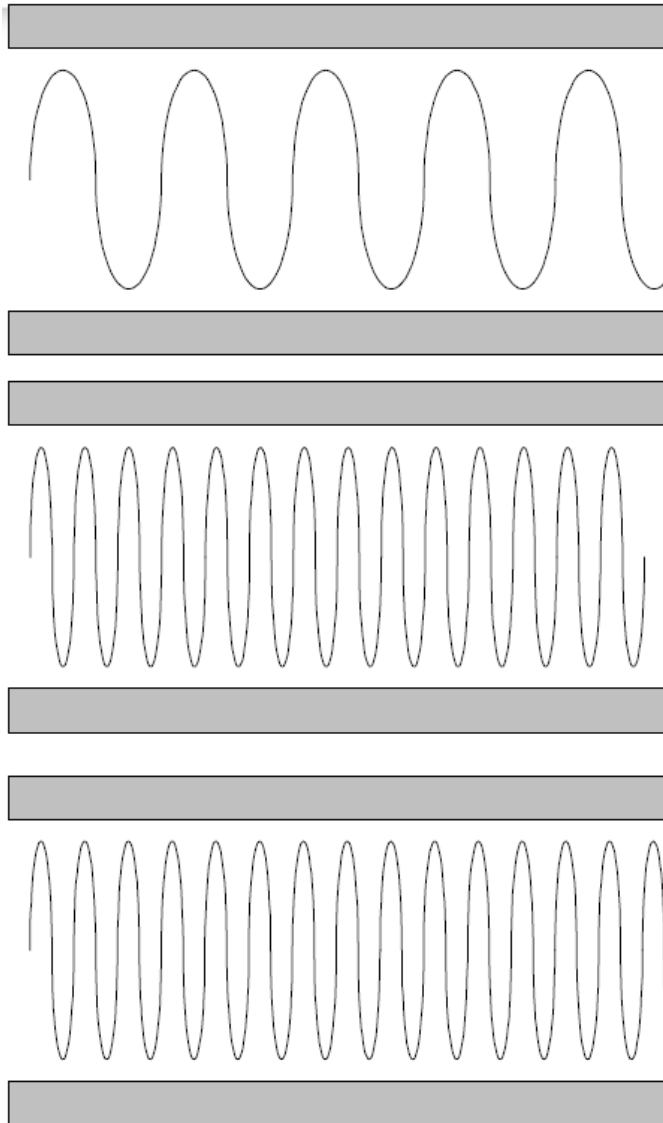

The ability of a quadrupole to resolve masses is proportional to frequency of AC and length of quadrupole

**Table 1. Comparison of Calculated and Measured Flows with Different Orifice Dimensions on a Triple Quadrupole Mass Spectrometer with HPI**

orifice diameter (mm)	measured flow into vacuum (L/min)	calculated flow with correction factor (L/min)
0	0	0
0.34	0.8	0.84
0.61	2.7	2.69
0.63	2.8	2.87
0.71	3.6	3.64
0.8	4.9	4.63
1.02	7.4	7.52
1.2	10	10.41

Computational fluid dynamics (CFD) modeling was conducted to improve our understanding of the gas flow characteristics through the DJET. CFD simulations were performed using the CFD++ commercial software suite (Metacomp Technologies). Temperature and pressure measurements were taken on the breadboard at various locations on and around the inlet orifice, DJET ion guide chamber, and QJET ion guide chamber, and these values were used in the CFD calculations. Figure 4 shows the calculated Mach number

*Ion Guide for Improved Atmosphere to Mass Spectrometer Vacuum Ion Transfer*  
 Hassan Javaheri and Bradley B. Schneider\* : *J. Am. Soc. Mass Spectrom.* 2021, 32, 1945–1951

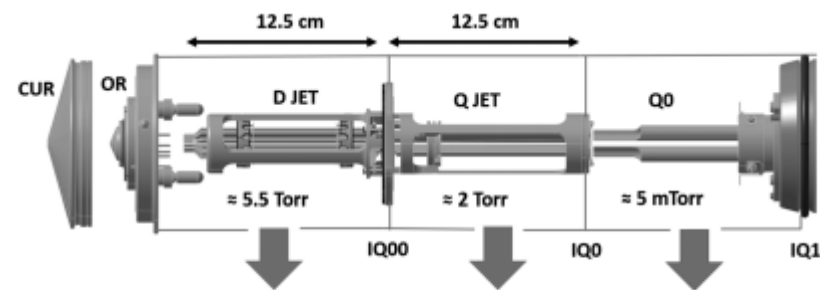

**Figure 1.** Schematic of the first three differentially pumped vacuum stages of the HPI. The schematic shows the curtain plate (CUR), orifice plate (OR), first dodecapole ion guide (DJET), first quadrupole ion guide (QJET), and second quadrupole ion guide (Q0). The IQ00, IQ0, and IQ1 lenses that separate the differentially pumped vacuum stages are also labeled.

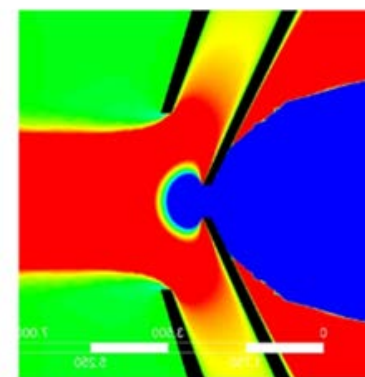

CP = 3 mm  
 OR = 0.6 mm

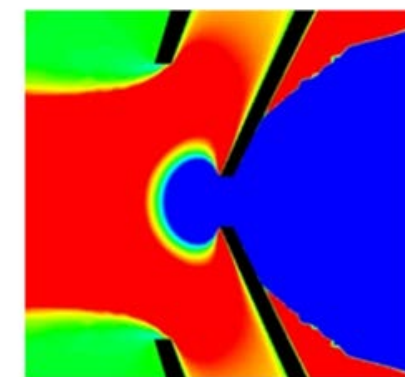

CP = 4 mm  
 OR = 0.72 mm

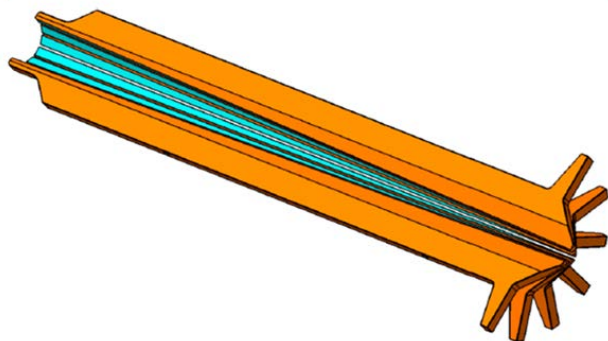

Figure 2. Schematic of the arrangement of rods for a dodecapole ion guide that captures the gas expansion into the first vacuum stage.

An RF-only ion-funnel for extraction from high-pressure gases  
 T. Brunnera, et al. *International Journal of Mass Spectrometry* 379 (2015) 110–120

Evaluation of a New DC-Ion Funnel Drift Tube for Use in Proton Transfer Reaction Mass Spectrometry  
 Qiangling Zhang, Xun Bao, Qu Liang, Qin Sun, Wei Xu, Xue Zou, Chaoqun Huang, Chengyin Shen,\* and Yannan Chu,  
*Anal. Chem.* 2022, 94, 7174–7180

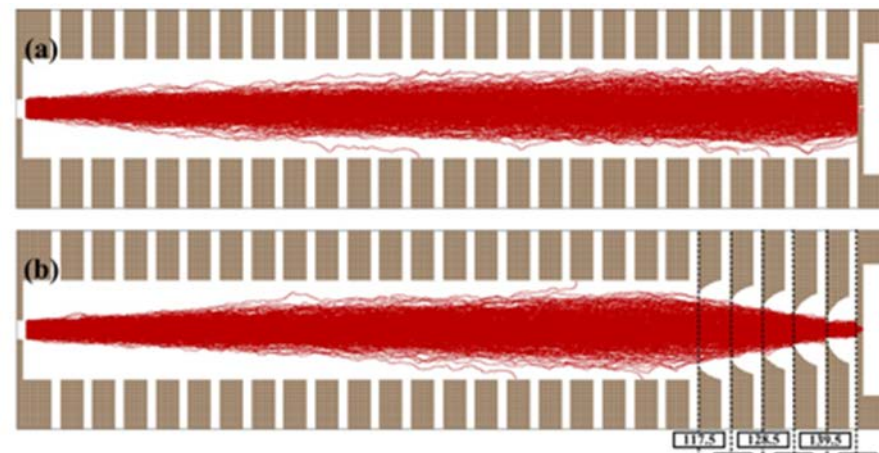
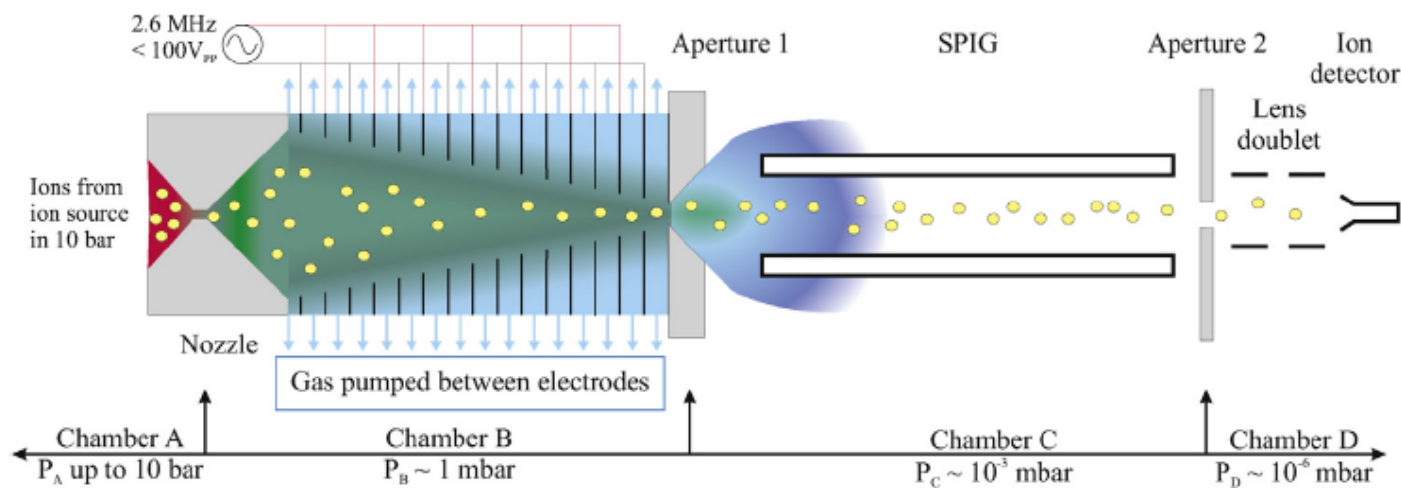
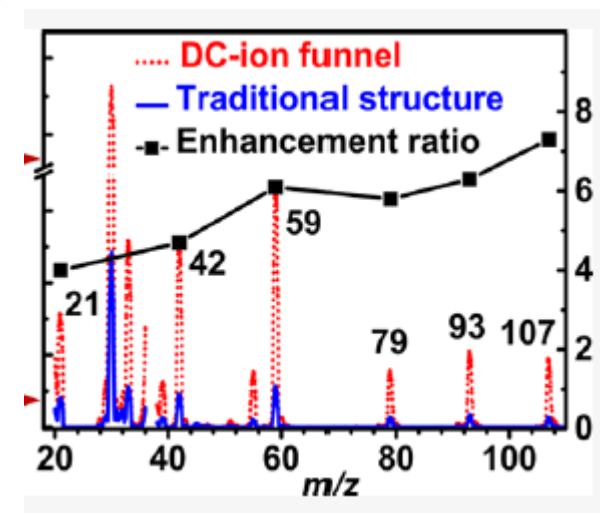

Figure 2. Ion trajectories of 100 Th in the (a) conventional drift tube and (b) DC-ion funnel drift tube. (c) Simulation results of E/N on the central axis Z for the traditional drift tube structure and the DC-ion funnel drift tube.





# Laboratories with SUM Z-Score < 2

Data on 2900 results in each PT-FV

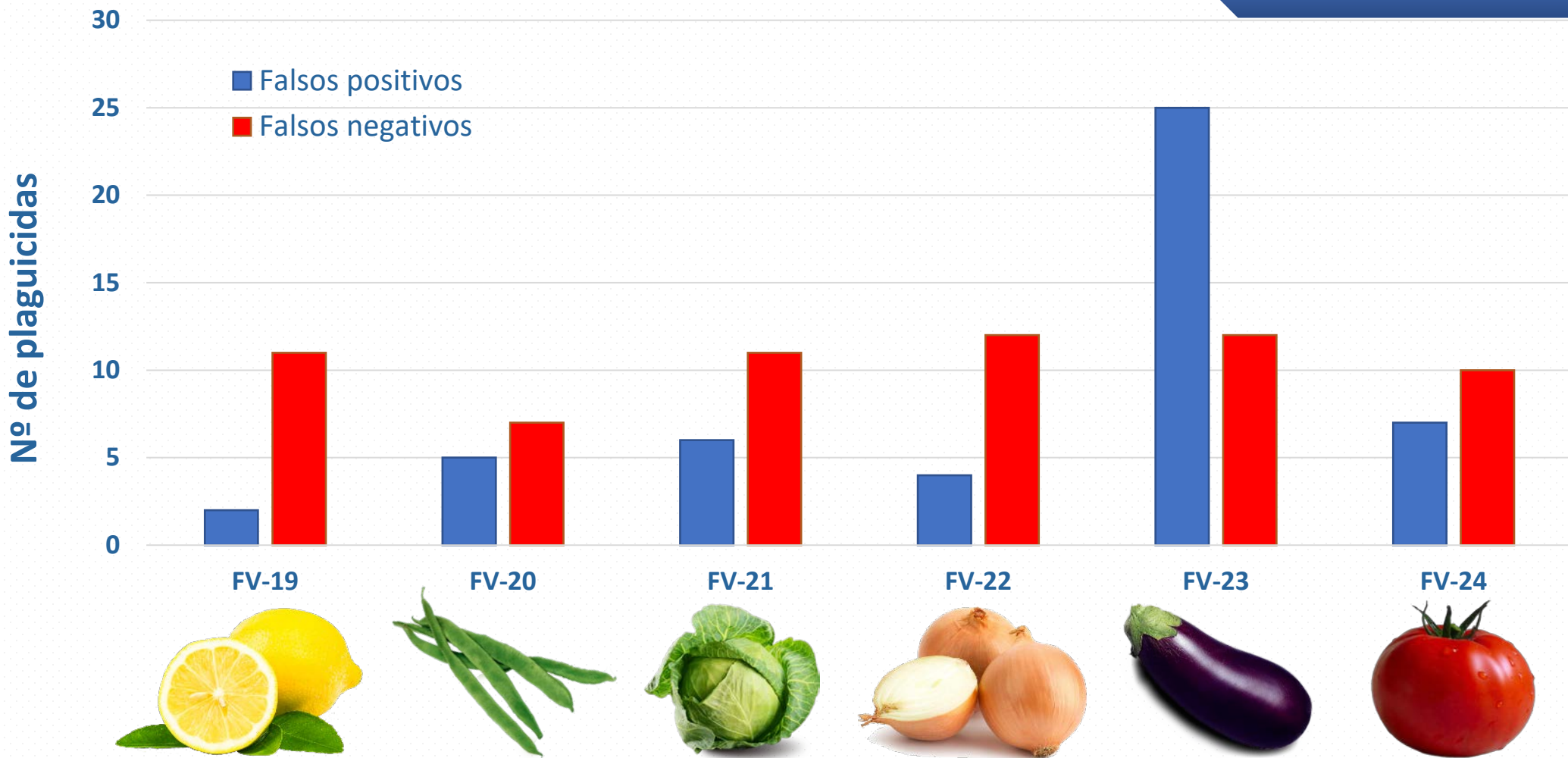

# MATRIX EFFECTS

COMMODITY SCOPE

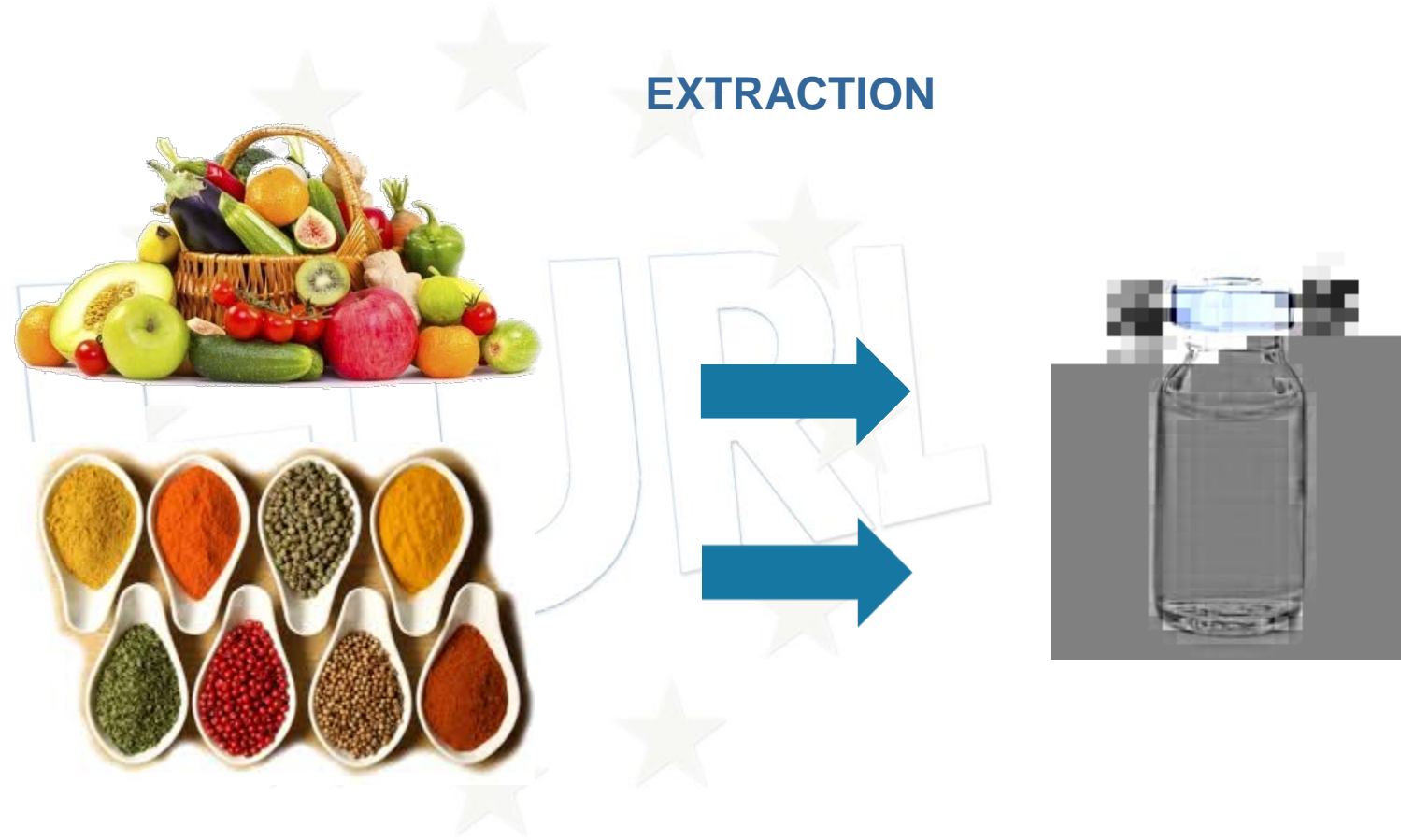

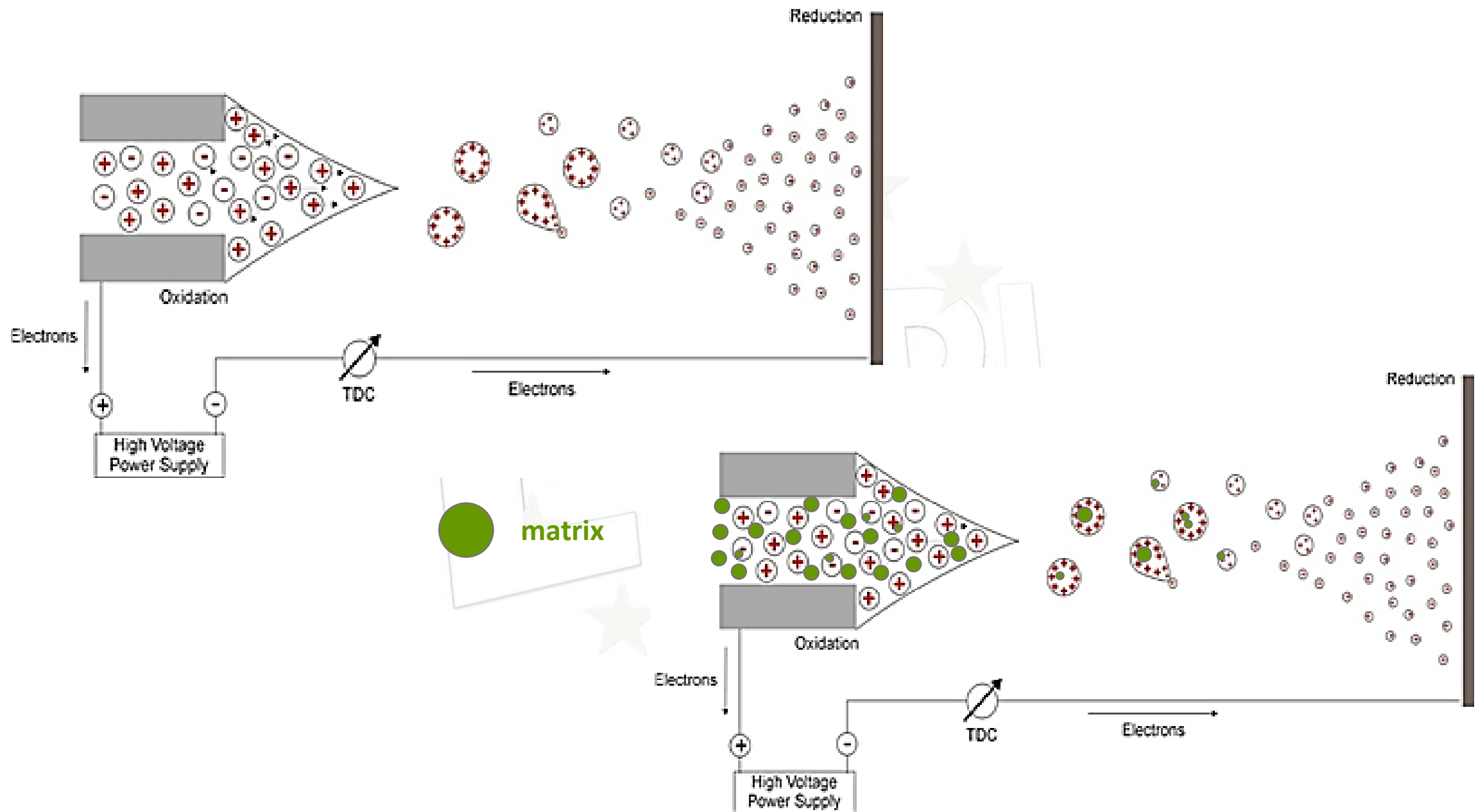

# TOTAL SIGNAL SUPPRESSION DUE TO MATRIX EFFECTS

Matrix spiked at 10 ppb with Chloroxuron

Injection 0.11 g matrix/ml

Ion transition: 291.2>217.8

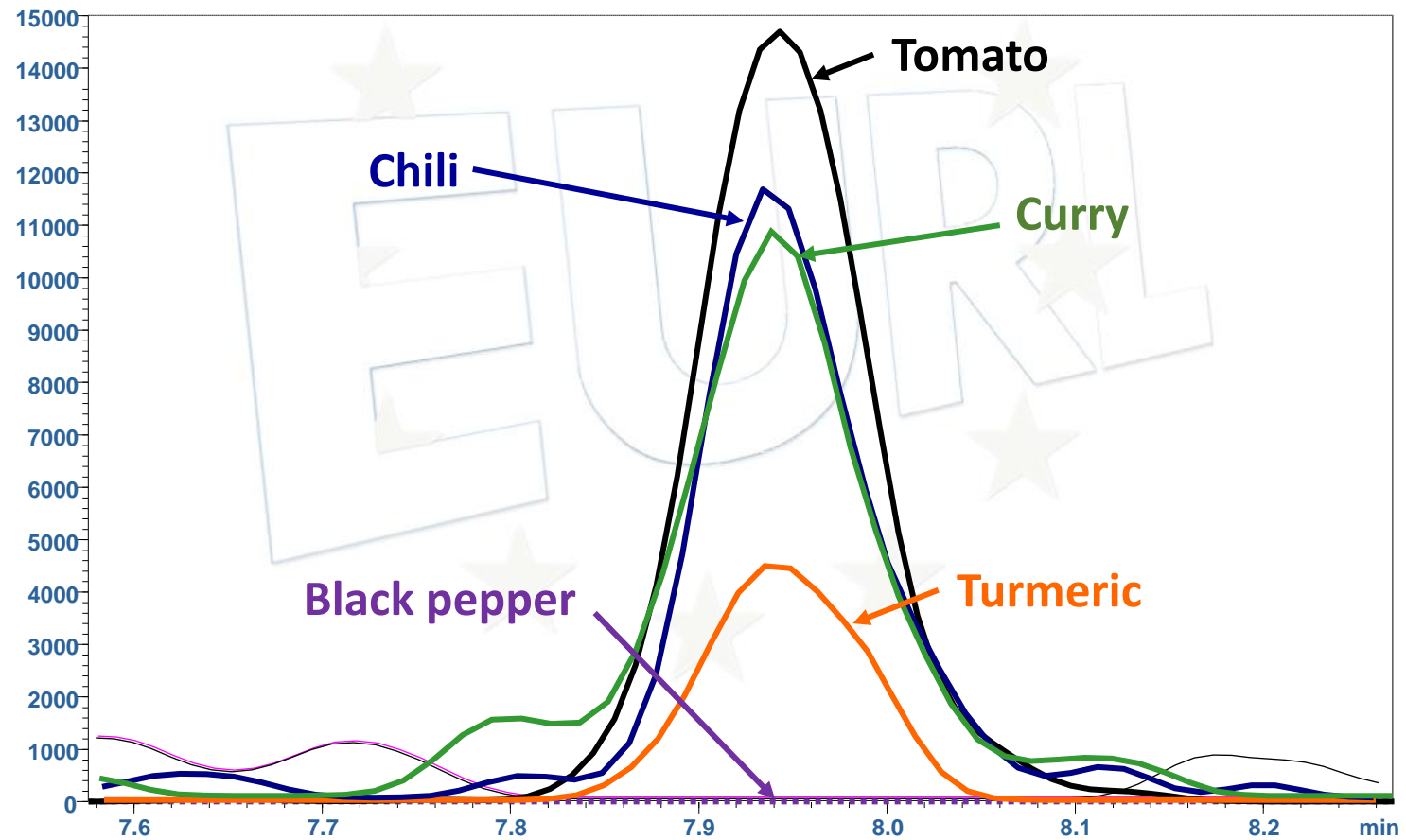

# Fenazaquin

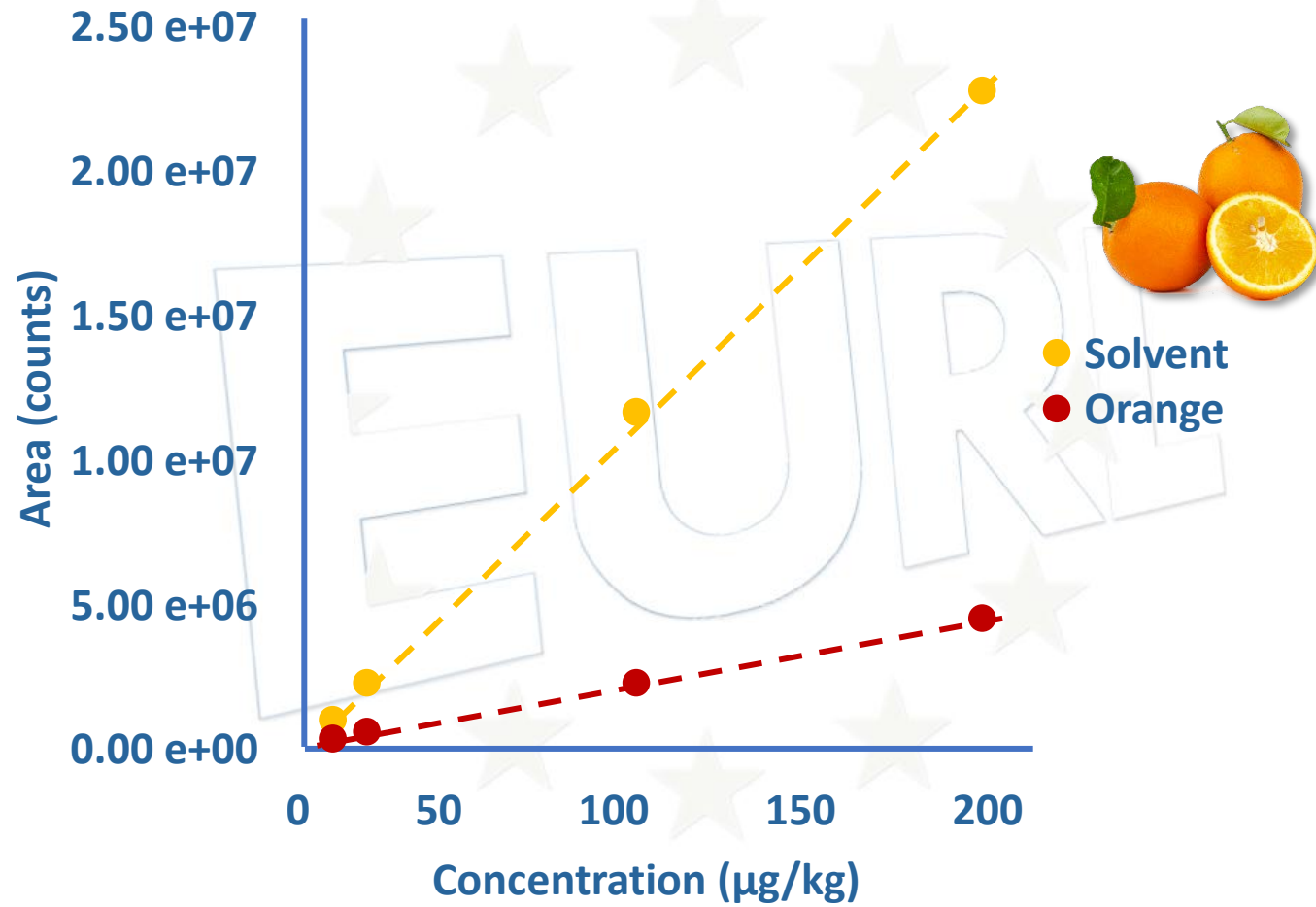



# False positives and false negatives

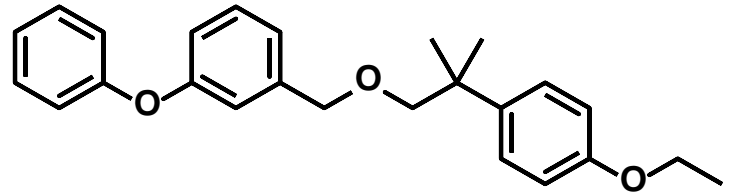

**Etofenprox**

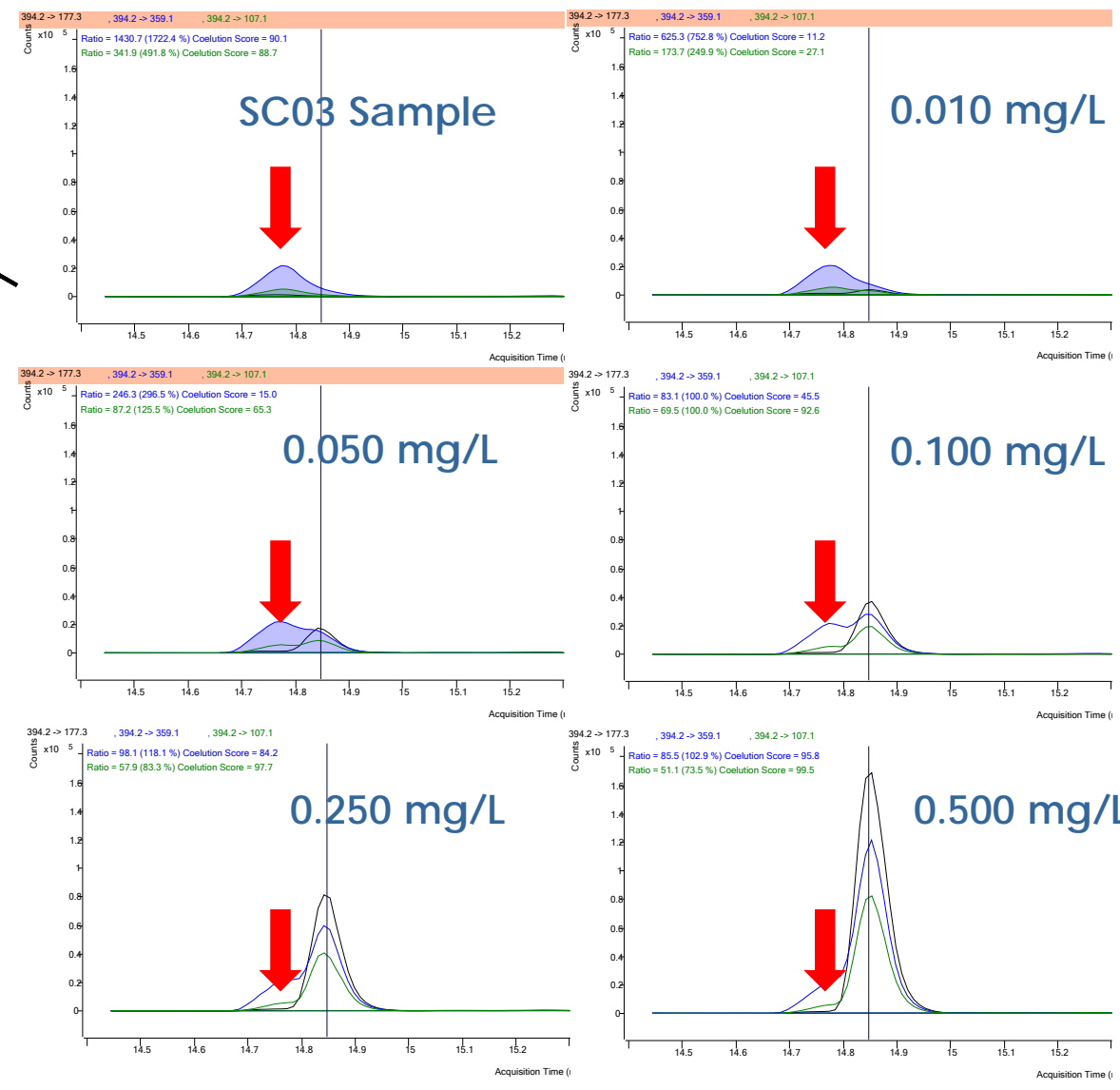

# Methamidophos in paprika

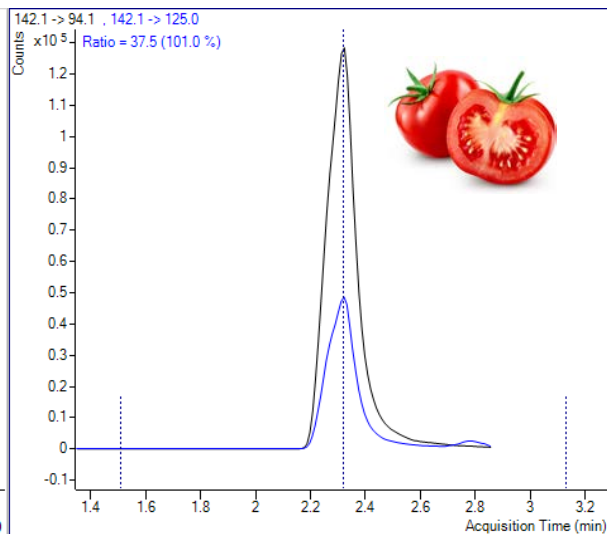
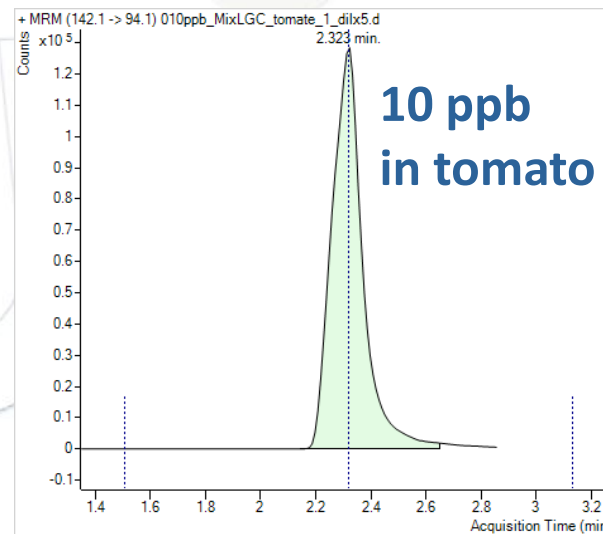
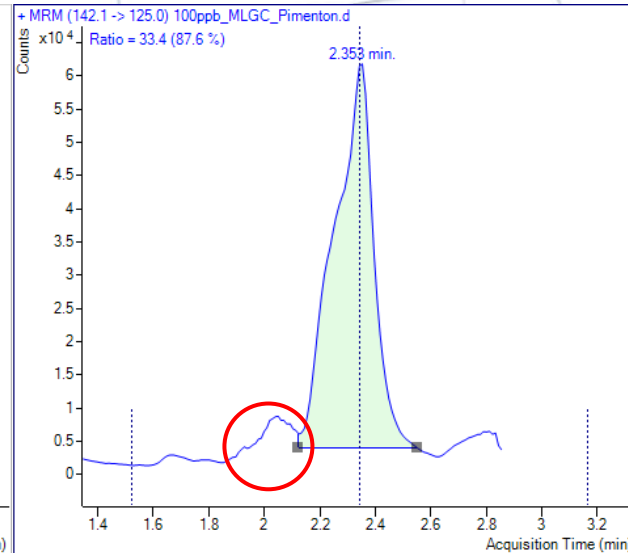
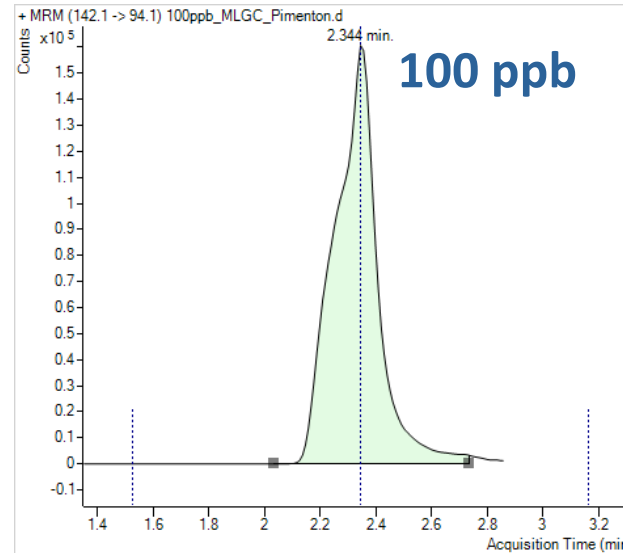
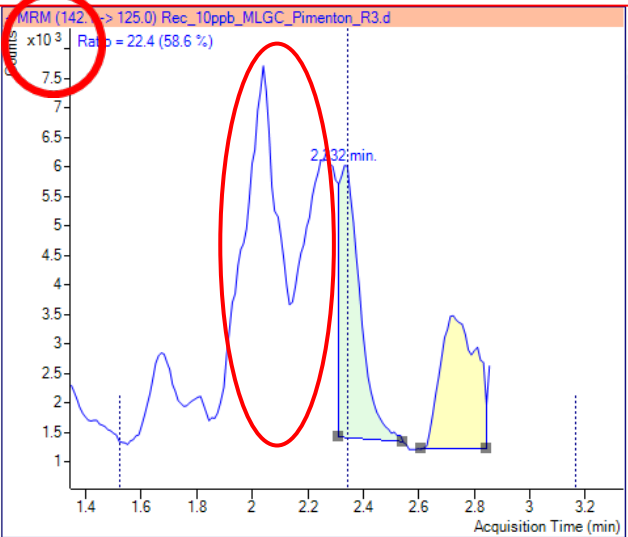
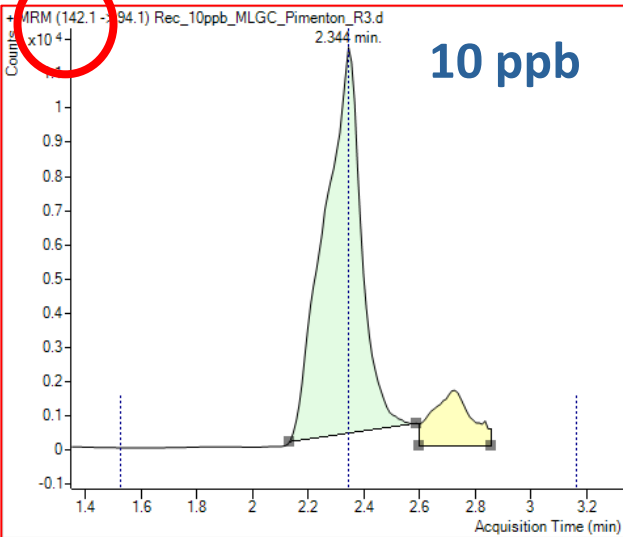
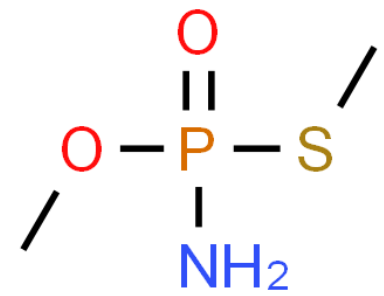

# SOLUTIONS AVAILABLE



IMPROVING  
SENSITIVITY



IMPROVING  
CHROMATOGRAPHY



IMPROVING  
CLEAN UP  
(automated)





Injection volume

Matrix injected in column

LC: 5 µL

GC: 1 µL

LC: 5 µL

5 mg

2.5 mg

1 mg

0.5 mg

0.25 mg

GC: 1 µL

1 mg

0.5 mg

0.2 mg

0.1 mg

0.05 mg



Green Tea

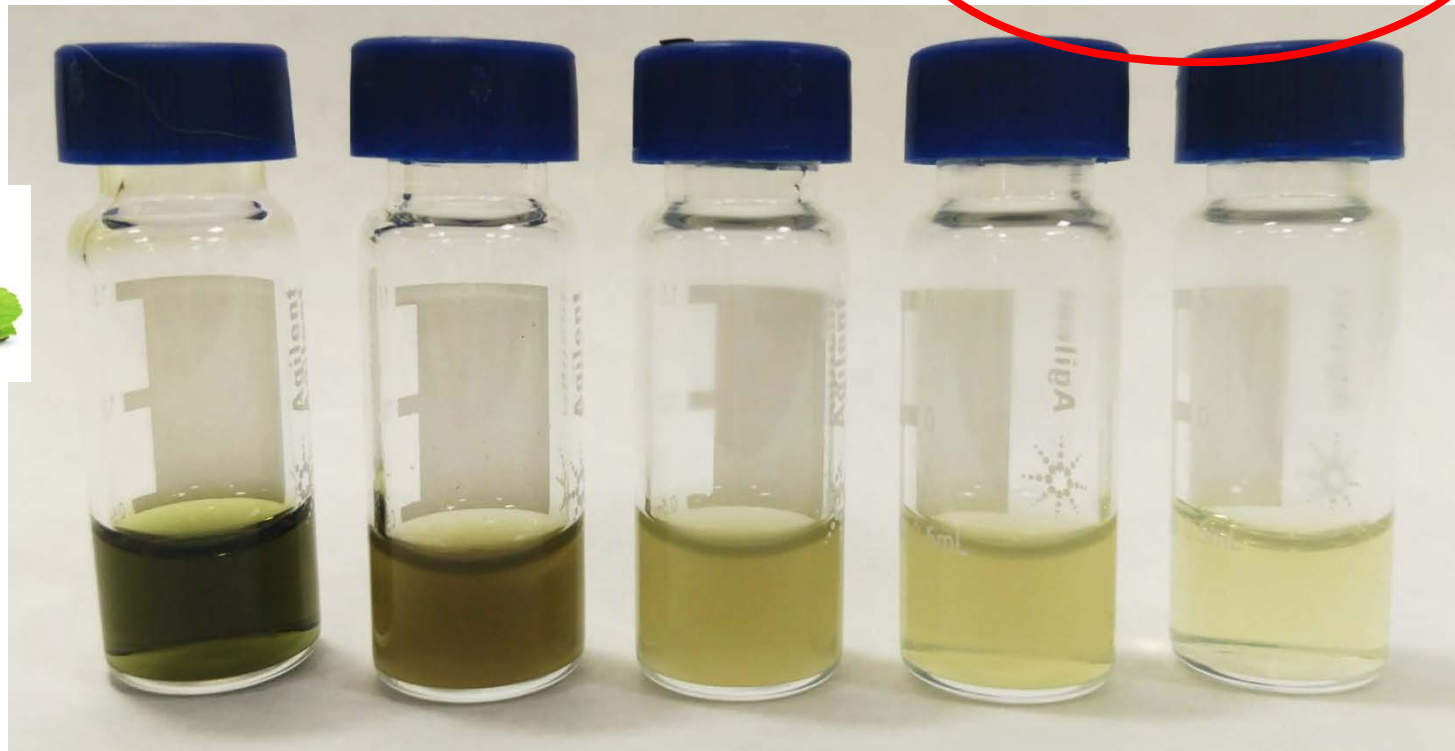

Dilx0  
1 g/mL

Dilx2  
0.5 g/mL

Dilx5  
0.2 g/mL

Dilx10  
0.1 g/mL

Dilx20  
0.05 g/mL

# Matrix effect of leek matrix over tomato matrix

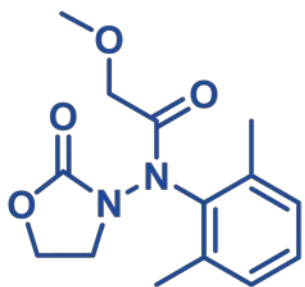

"Matrix effect" at 2.5  $\mu\text{L}$ : -8.9 %

"Matrix effect" at 5.0  $\mu\text{L}$ : -37 %

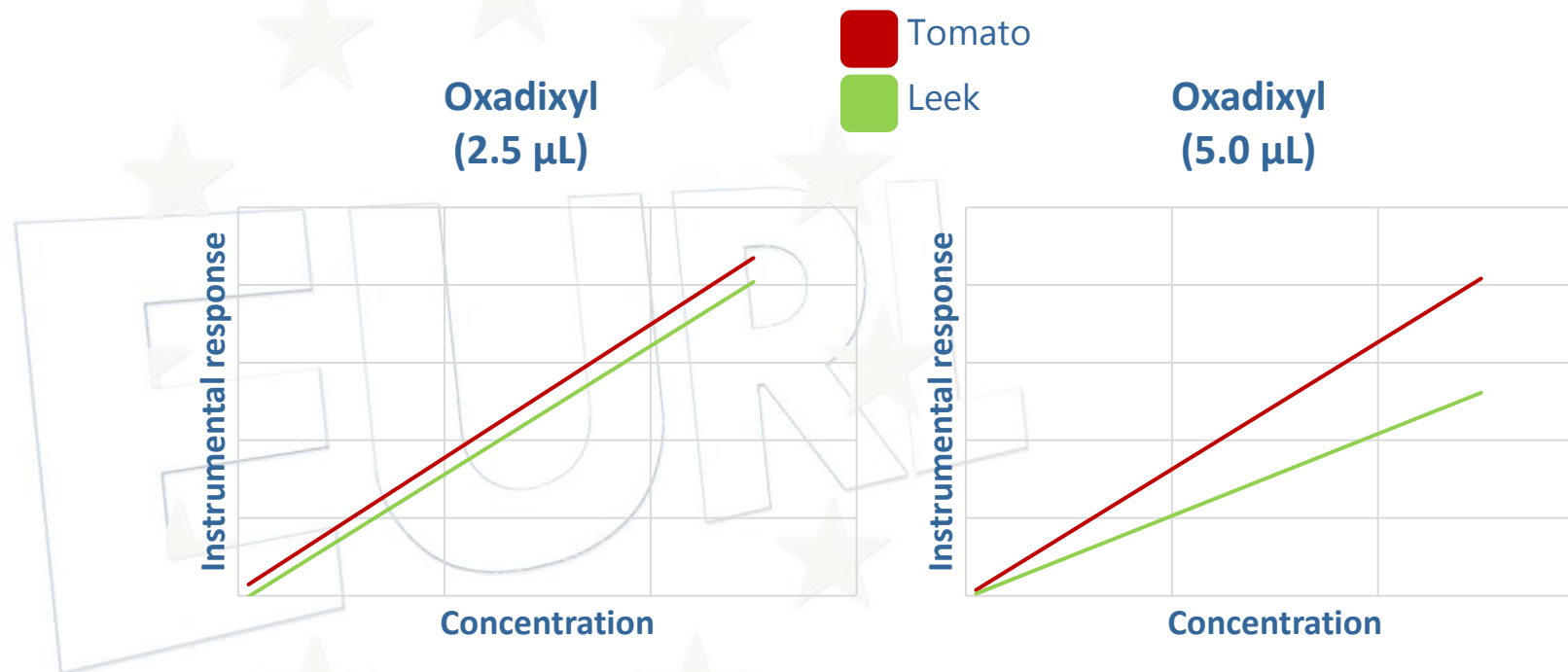

# Matrix effect of leek matrix over tomato matrix (250 compounds)

Relative matrix effect

	Leek/Tomato (2.5 µL)	Leek/Tomato (5.0 µL)
Average (%)	-6.6 %	-19.4 %
Median (%)	-7.3 %	-20.9 %
<=  20 %	168	111
>  20 %  & <=  50 %	76	111
>  50 %	6	28
<=  20 %  (%)	67.2 %	44.4 %
>  20 %  & <=  50 %  (%)	30.4 %	44.4 %
>  50 %  (%)	2.4 %	11.2 %





## IMPROVING CLEAN UP (automated)

# μSPE cartridge

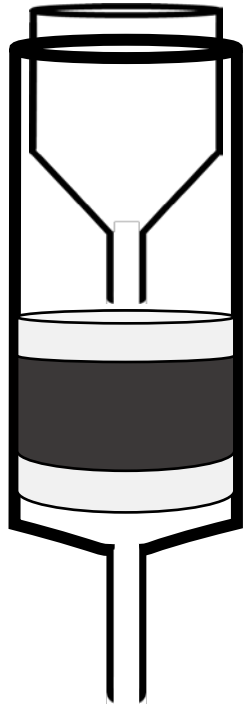

**MgSO<sub>4</sub> (20mg)**  
**PSA (12 mg)**  
**C<sub>18</sub> (12 mg)**  
**GCB (1 mg)**

- Small dead volumen (< 20μL)
- Pressure tolerance: 15 bar
- Wide range of sorbent masses: 5-150 mg
- Porous filters allow multiple sorbent layers
- Sorbent mass accuracy+/-0,5mg
- Composition:
  - 20 mg Anhydrous MgSO<sub>4</sub>+
  - 12mg PSA+
  - 12 mg C18+
  - 1 mg CarbonX

pre-mixed beforehand  
 45mg of the mix in each cartridge

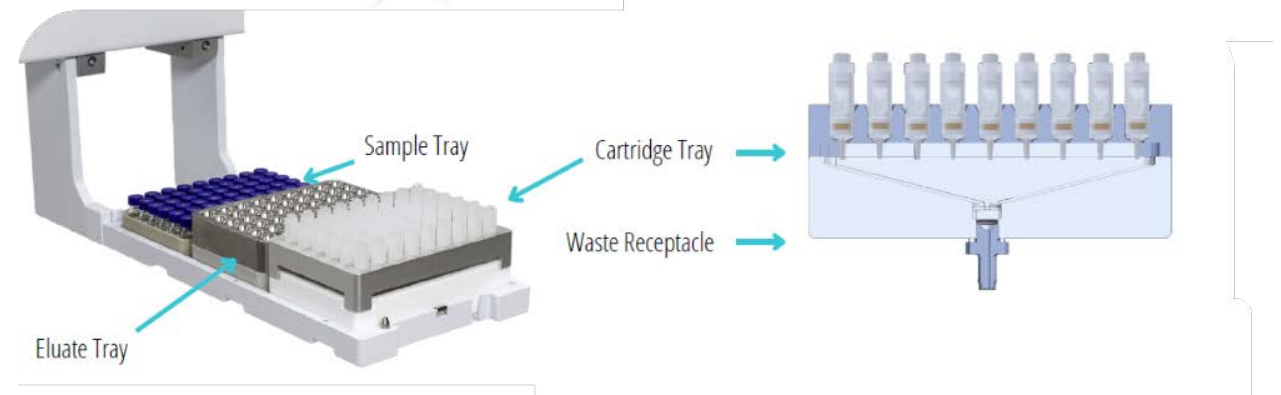



# TIC of avocado

dSPE  
PSA



Automated  
μSPE

RT: 0.00 - 20.91

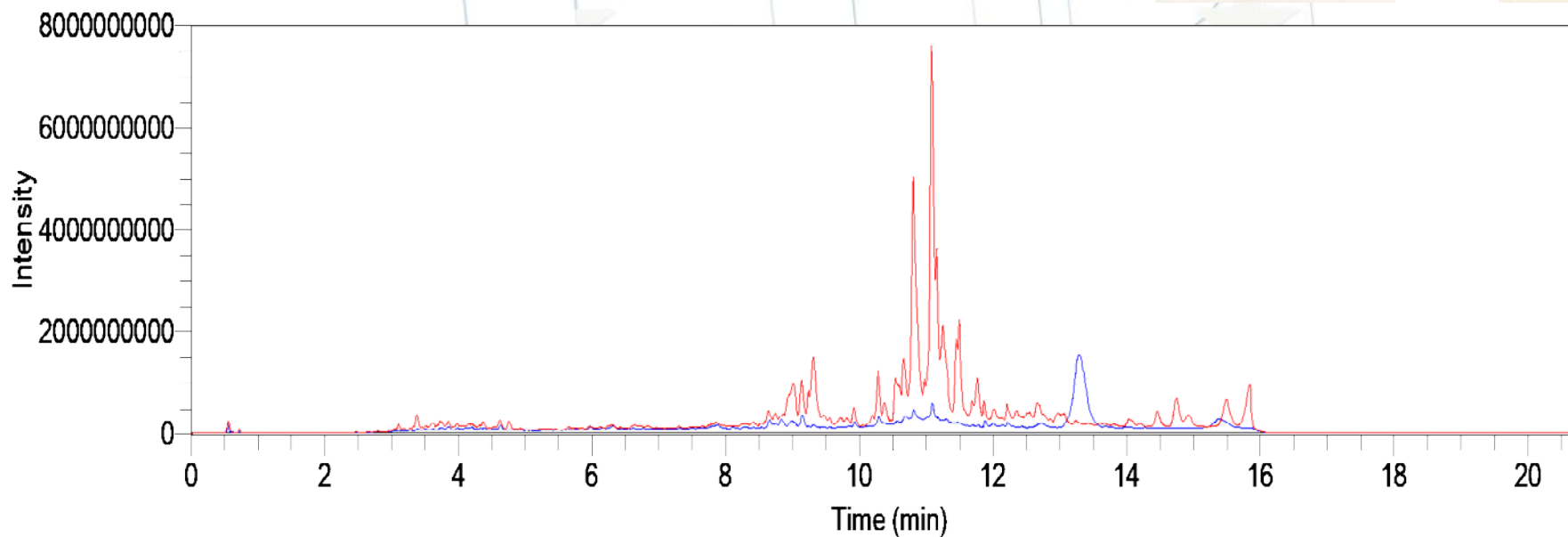

# Fluazifop

**High Sensitive**

Spiked standard 10 µg/kg

Total injected amount: 0.33 mg Avocado

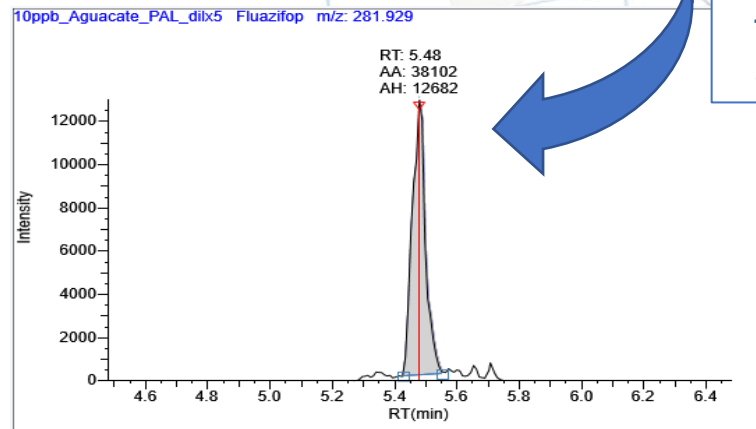
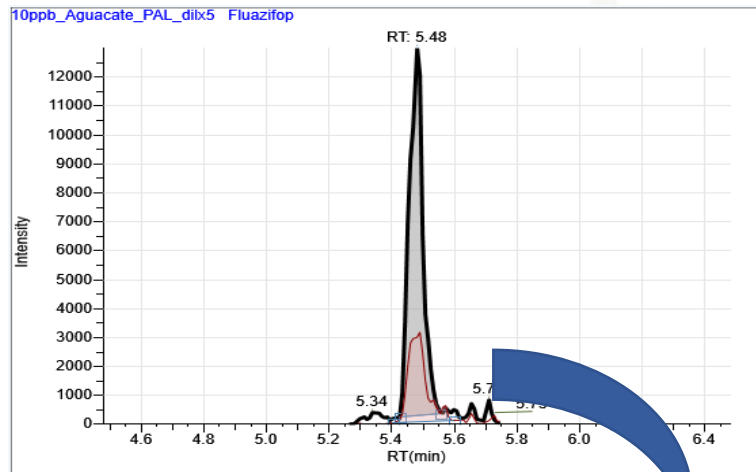

**Qualifier transition:  
 329 -> 282**

**Regular**

Spiked standard 10 µg/kg

Total injected amount: 0.66 mg Avocado

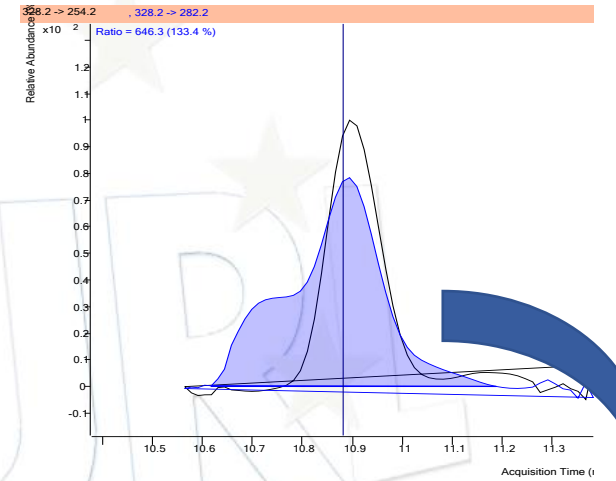

**Qualifier transition:  
 329 -> 282**

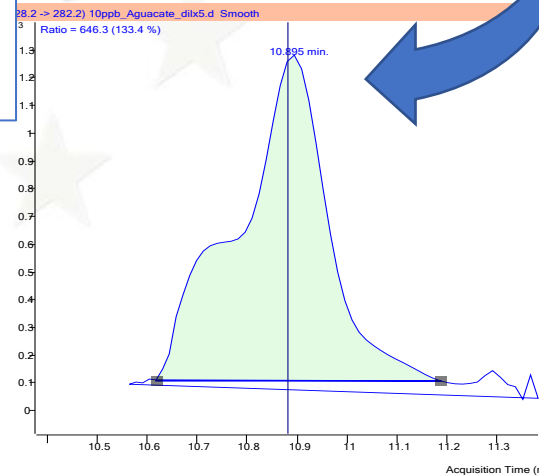

# Epoxiconazole

High sensitive

Spiked standard 10 µg/kg  
 Total injected amount: 0.066 mg Paprika

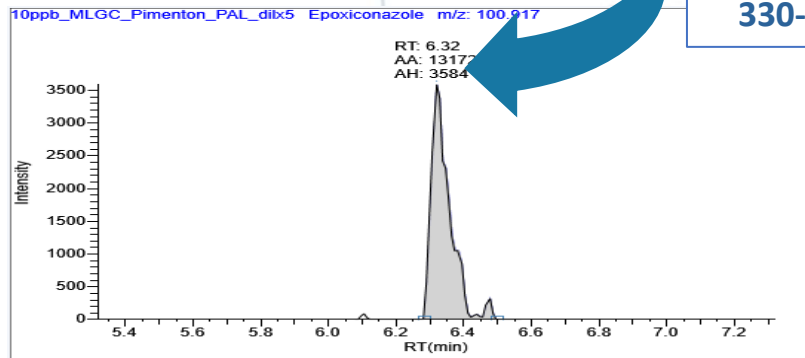
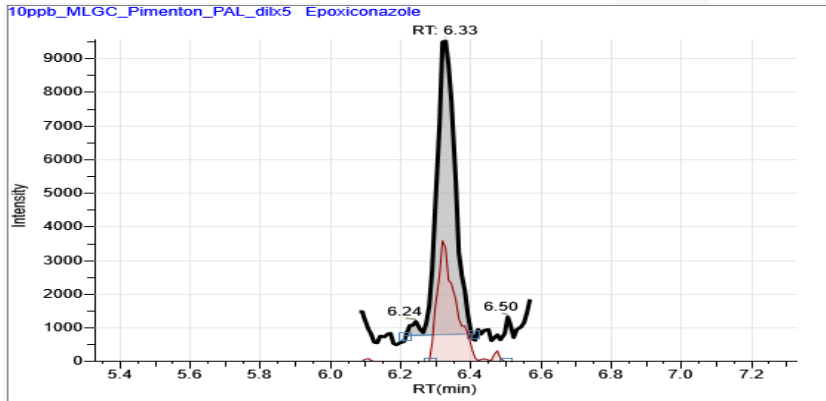

Qualifier transition:  
 330->101

Regular

Spiked standard 10 µg/kg  
 Total injected amount: 0.13 mg Paprika

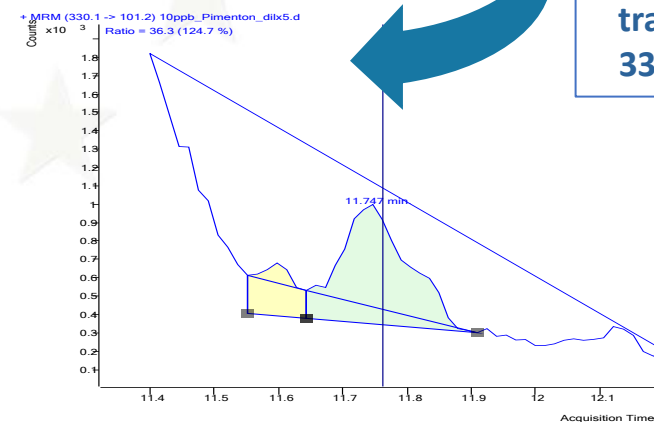
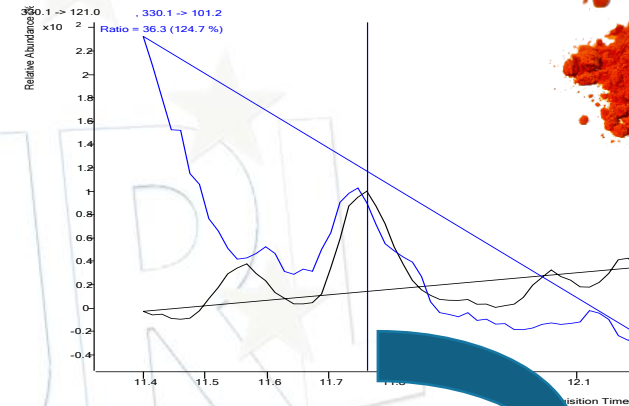

Qualifier transition:  
 330 -> 101



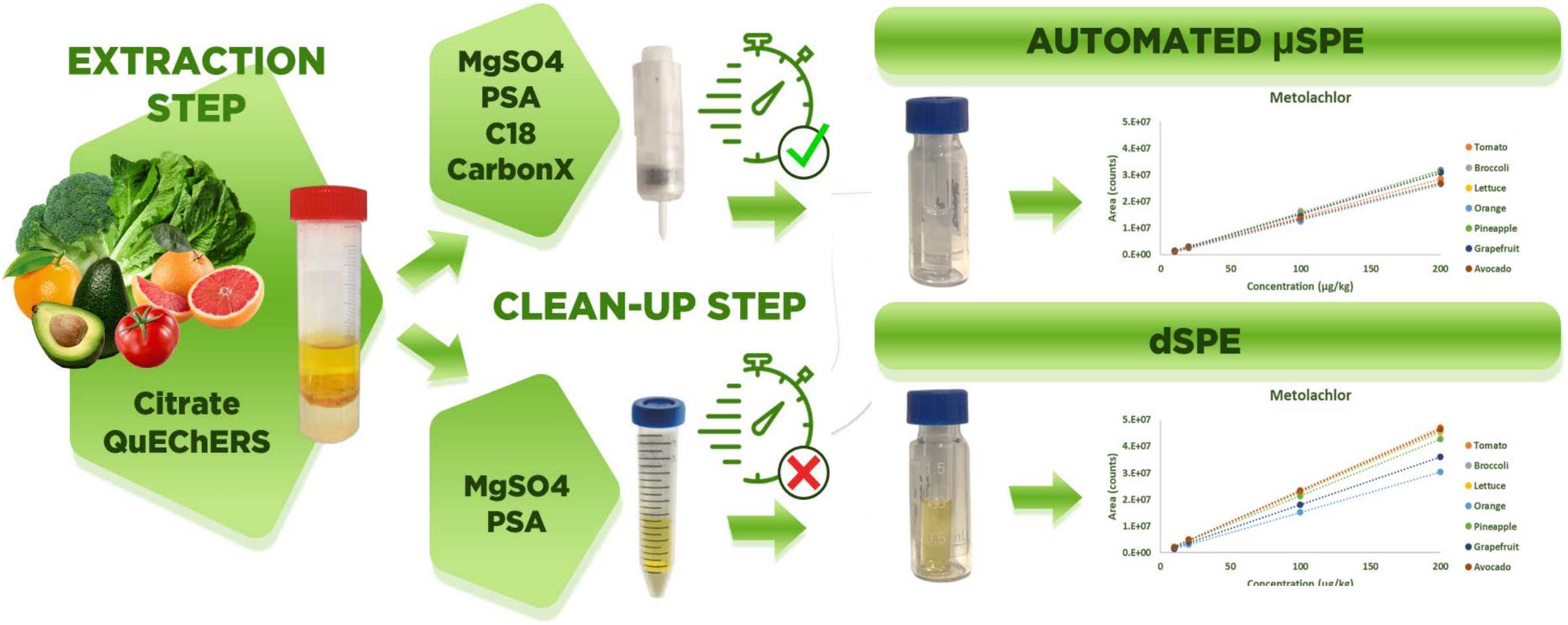



# IMPROVING CHROMATOGRAPHY

### Orange extract TIC

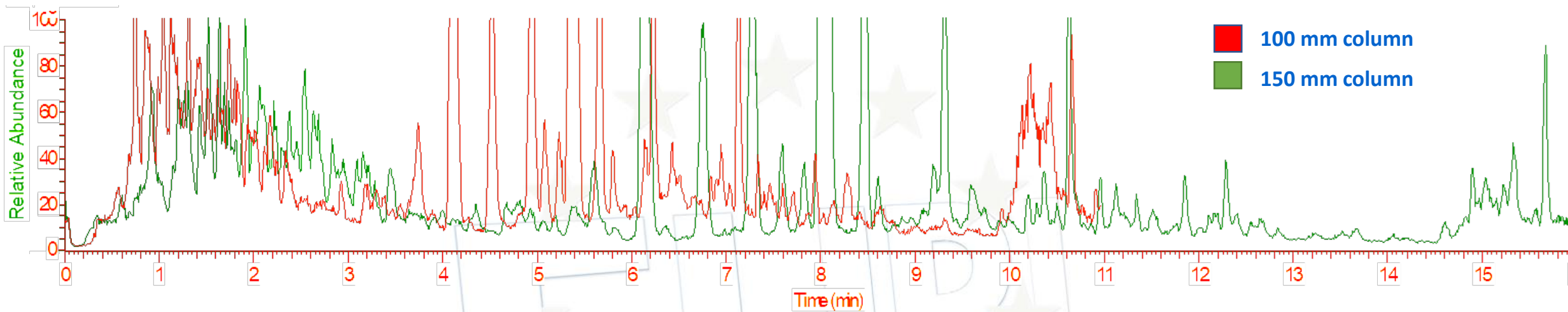

### Leek extract TIC

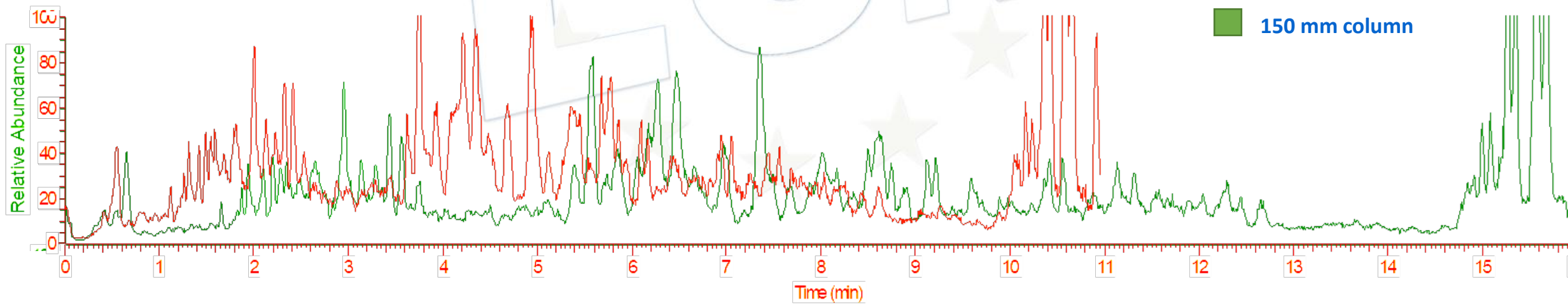

# Shorter column or higher gradient:



Onion matrix. TIC m/z 100 - 1000

Chromatographic method length

- 14 minutes
- 10.5 minutes
- 7 minutes

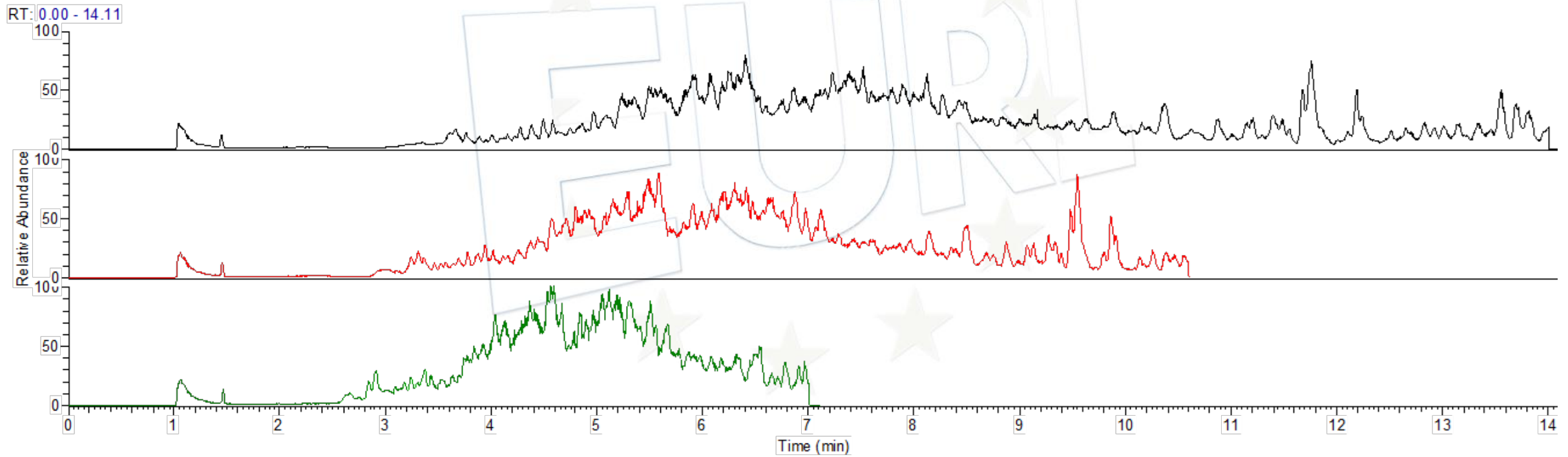

TARGET LIST

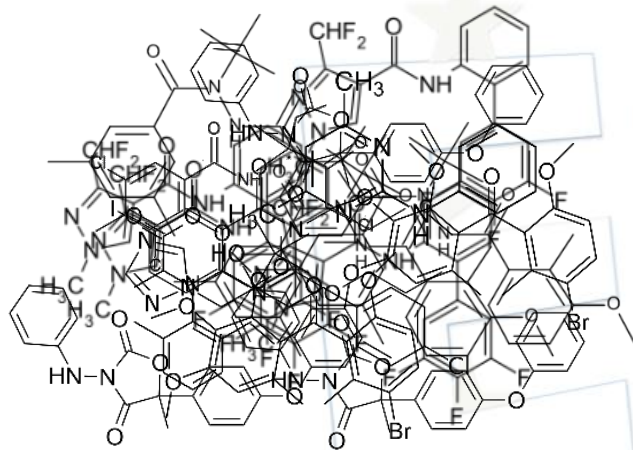

TARGET LIST



600

## Tentative false positives and negatives: common mass transitions

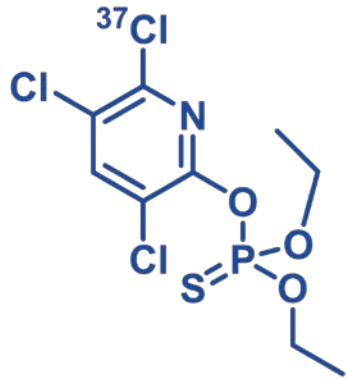

**Chlorpyrifos (<sup>37</sup>Cl<sup>35</sup>Cl<sub>2</sub>)**  
C9H11Cl2<sup>37</sup>ClNO3PS  
 Exact Mass: 350,9233 Da

352 > 200  
 352 > 125

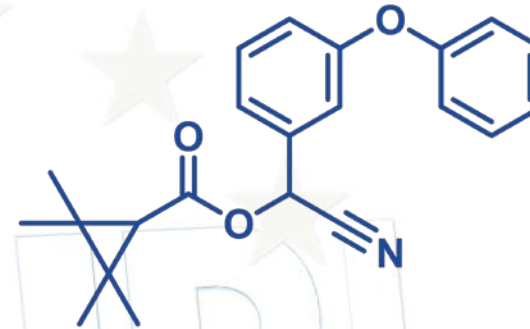

**Fenpropathrin**  
 Exact mass: 349.1678 Da

367 > 350  
 367 > 125  
**350 > 125**  
**350 > 97**

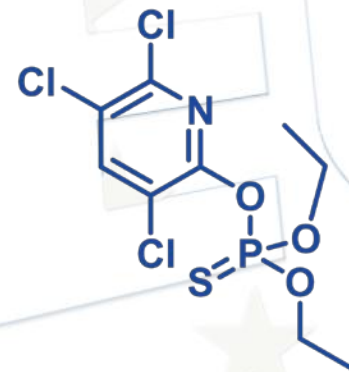
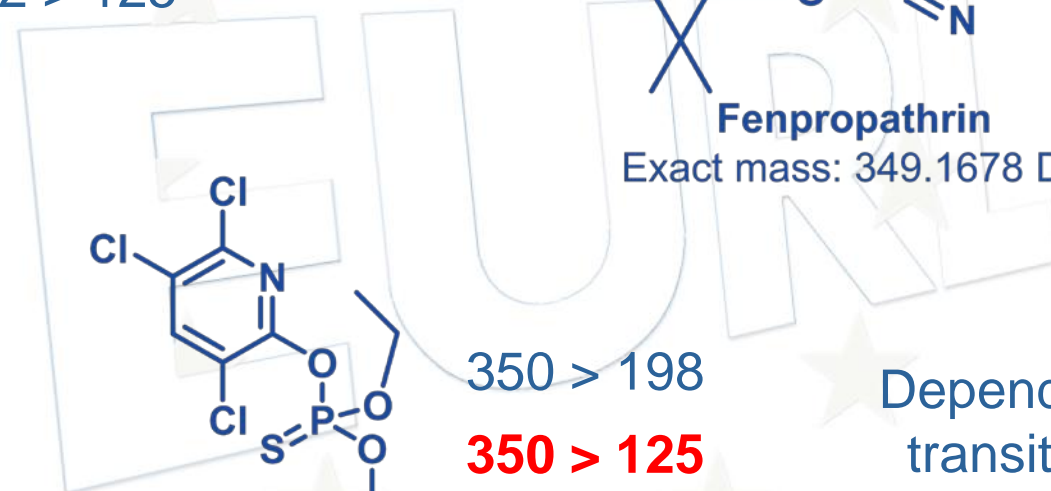

**Chlorpyrifos (<sup>35</sup>Cl<sub>3</sub>)**  
C9H11Cl3NO3PS  
 Exact Mass: 348,9263 Da

350 > 198  
**350 > 125**  
**350 > 97**

Depending on the selected mass transitions in LC-QqQ-MS/MS, false positives or negatives might be reported for chlorpyrifos and fenpropathrin

# SOLUTIONS AVAILABLE



IMPROVING  
SENSITIVITY



IMPROVING  
CHROMATOGRAPHY



IMPROVING  
CLEAN UP  
(automated)



# Interconversion - clofentezine

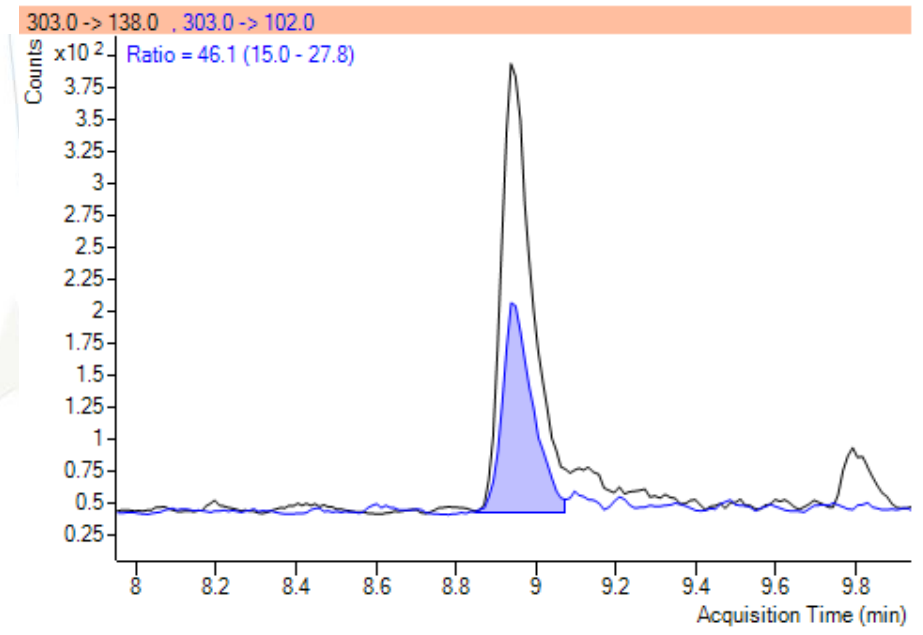
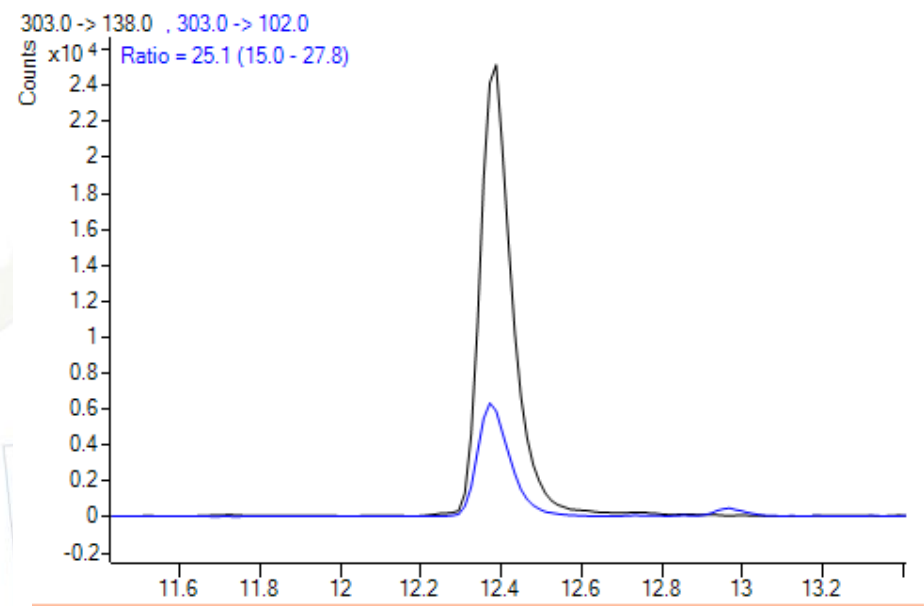
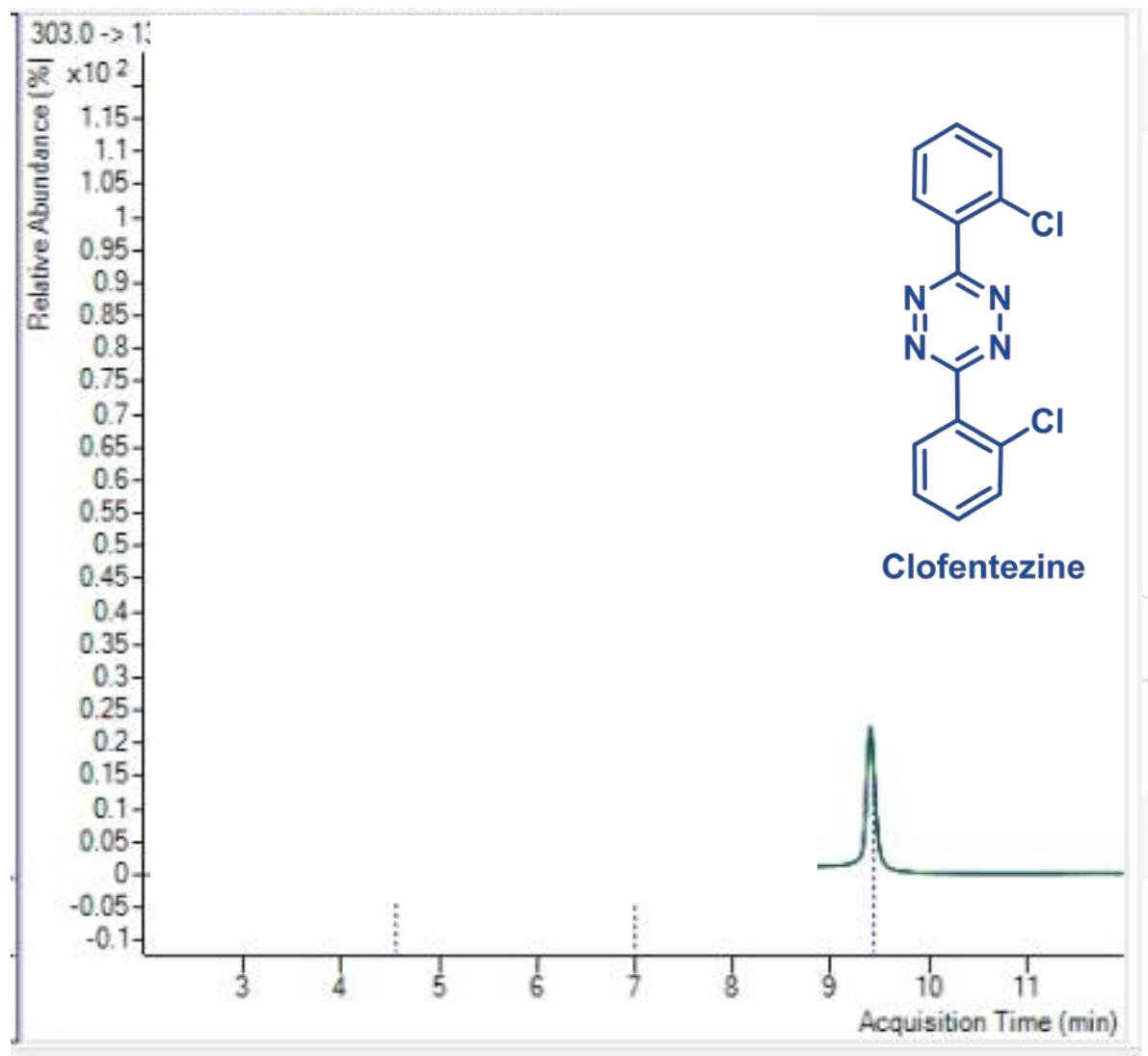



# Interconversion - clofentezine

High percentage of formic acid in the mobile phase  
 and/or little to no ammonium formate

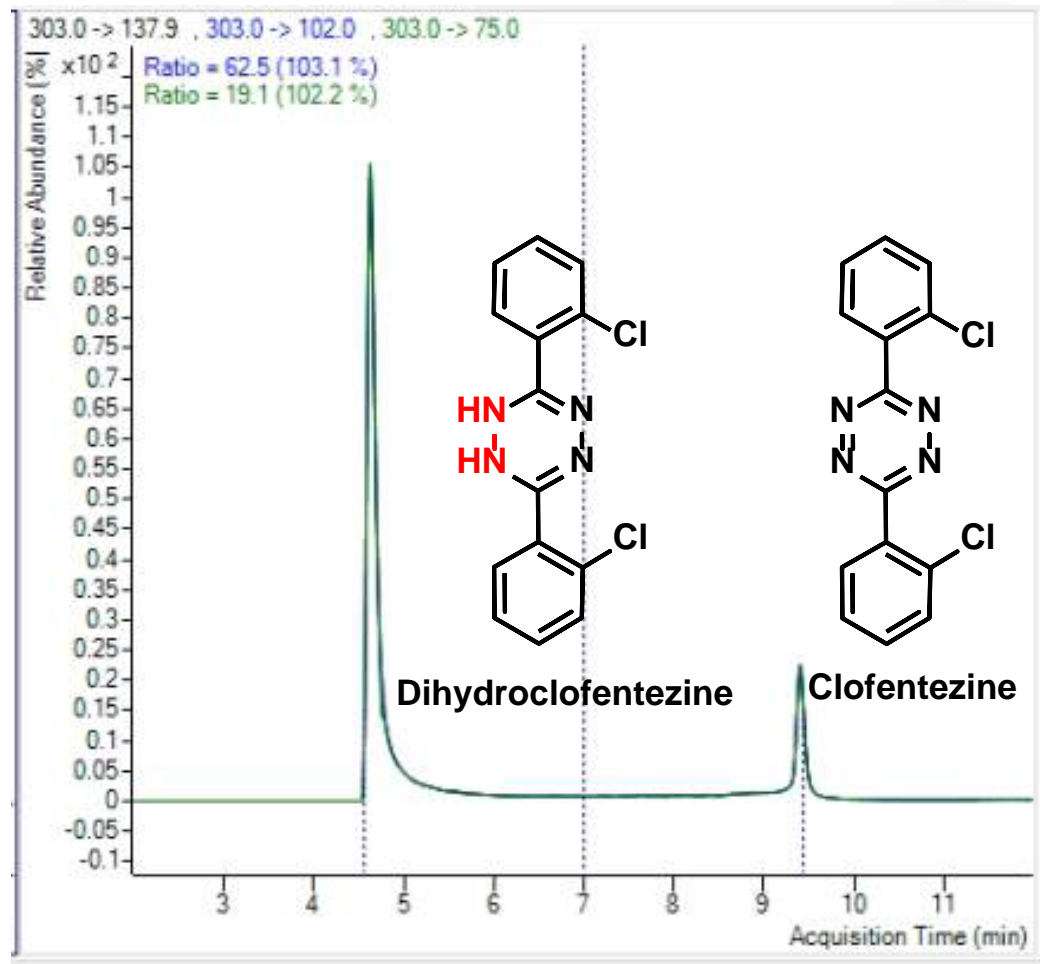

Low percentage of formic acid in the mobile phase  
 and/or ammonium formate

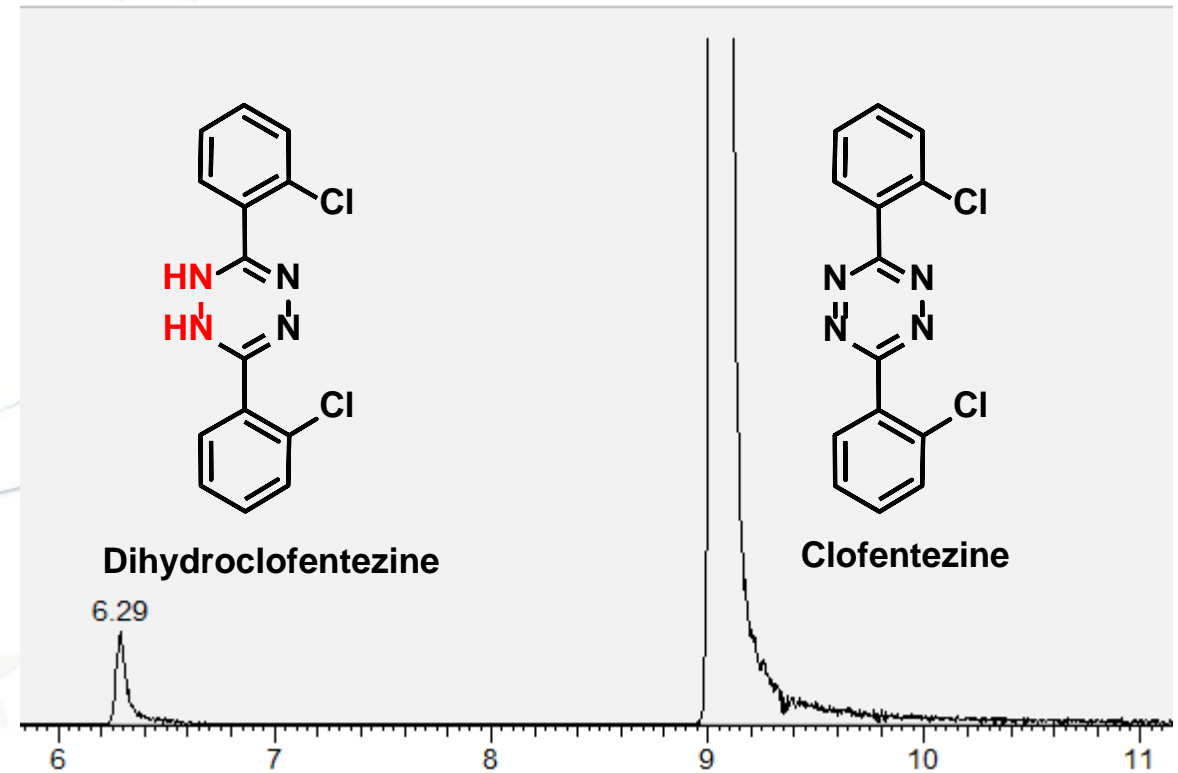



# False positives and false negatives

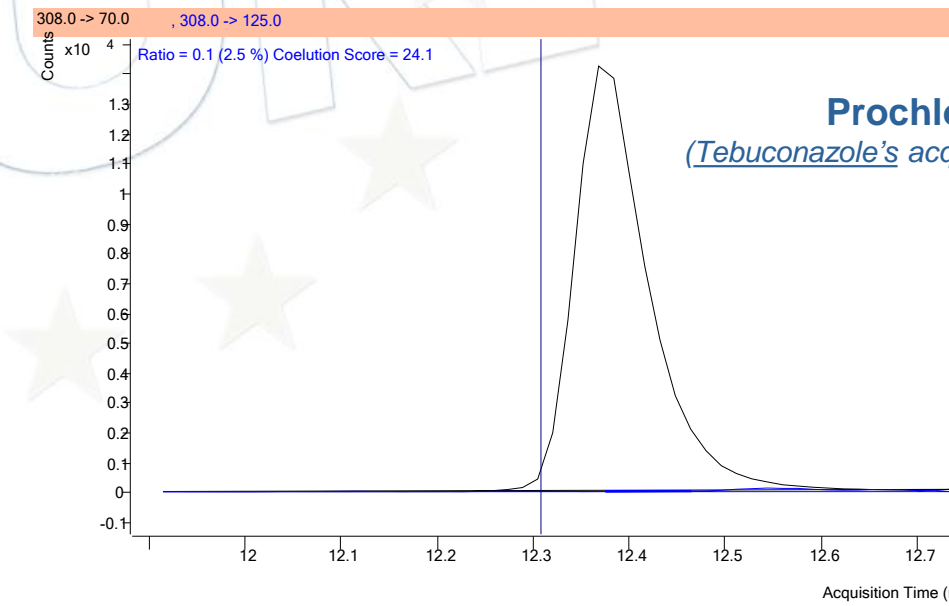
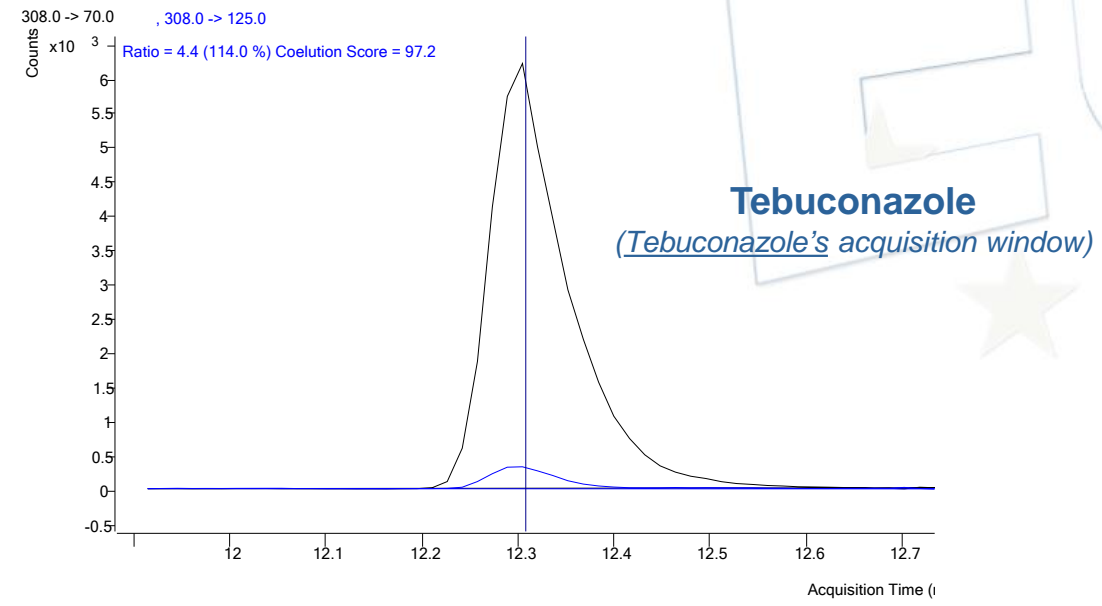
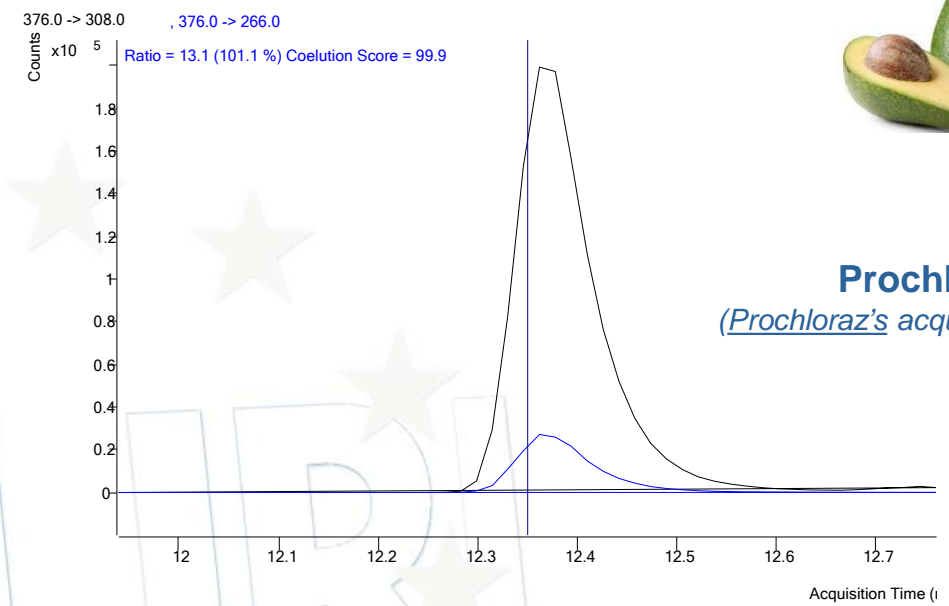
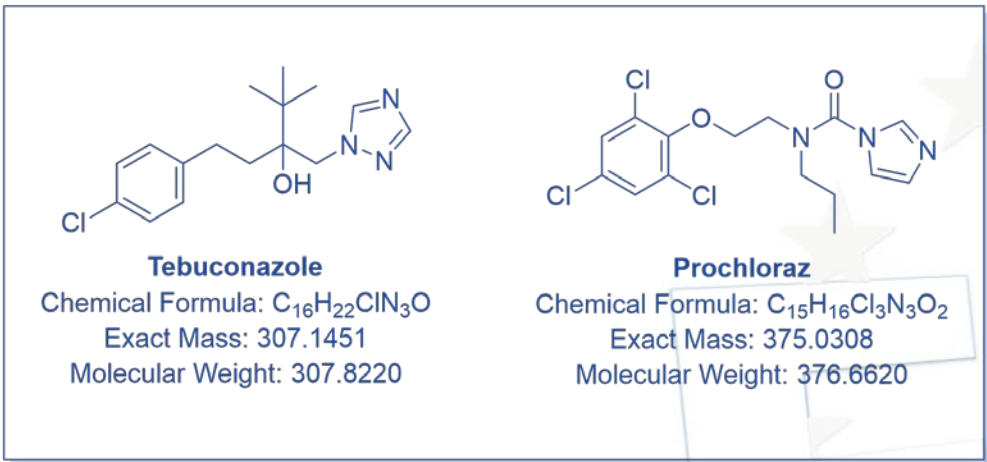



# False positives and false negatives

376 > 308

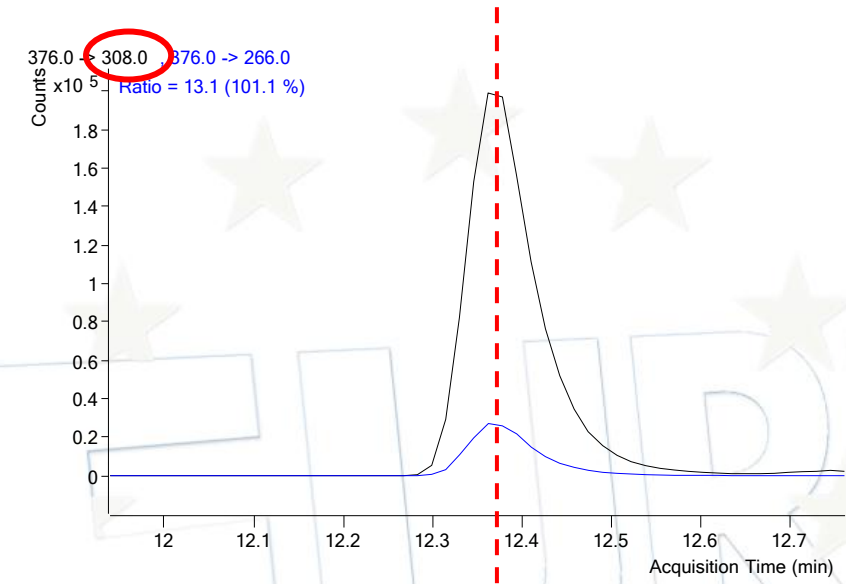

Prochloraz in SC03 sample  
(Prochloraz's acquisition window)

308 > 70

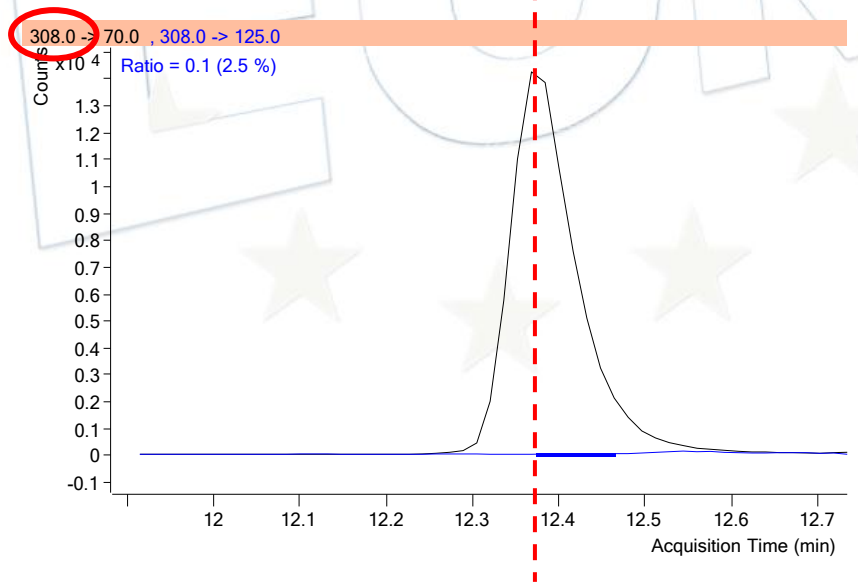

Prochloraz in SC03 sample  
(Tebuconazole's acquisition window)



# High-resolution mass spectrometry

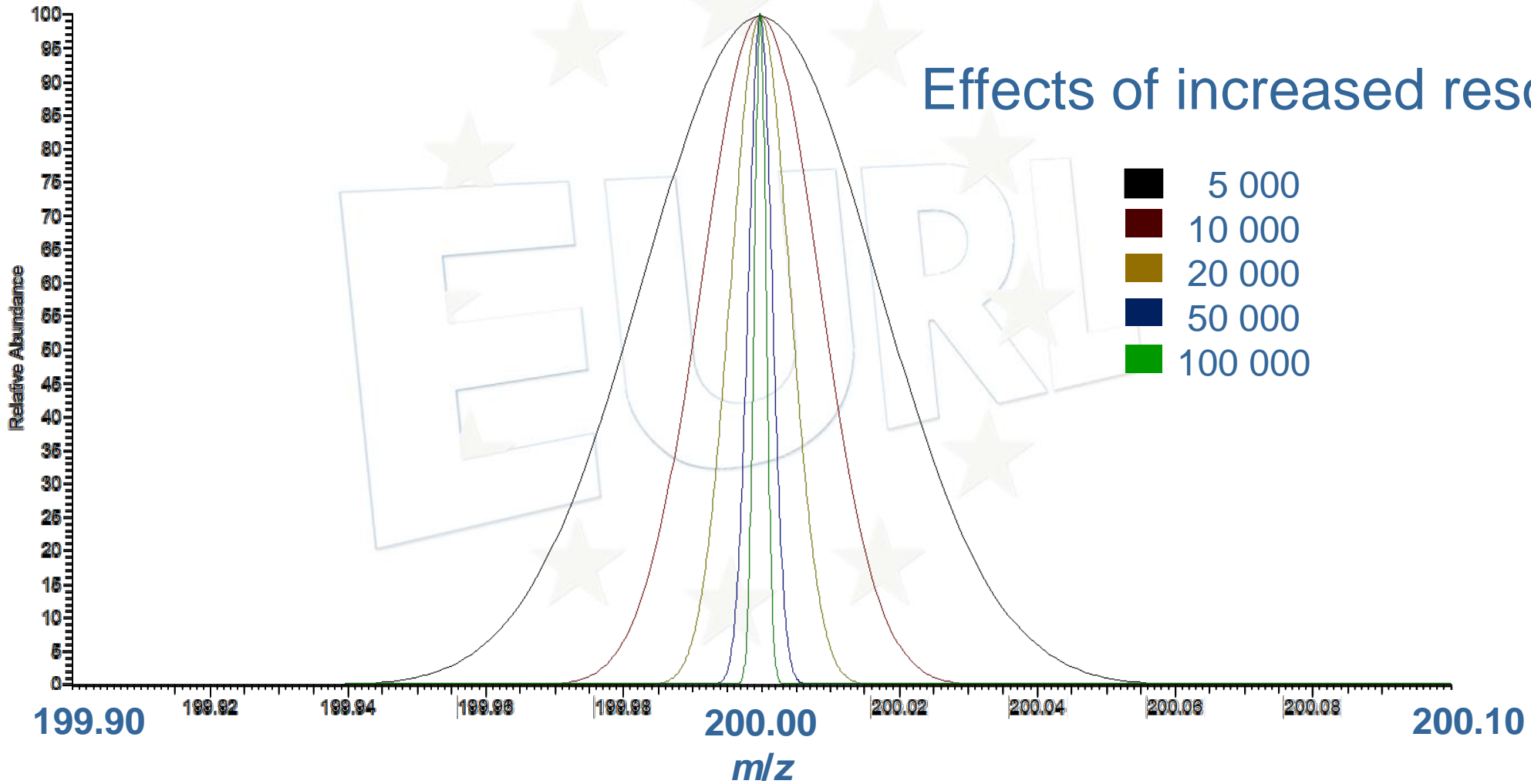

# High-resolution mass spectrometry

## Effects of increased resolution

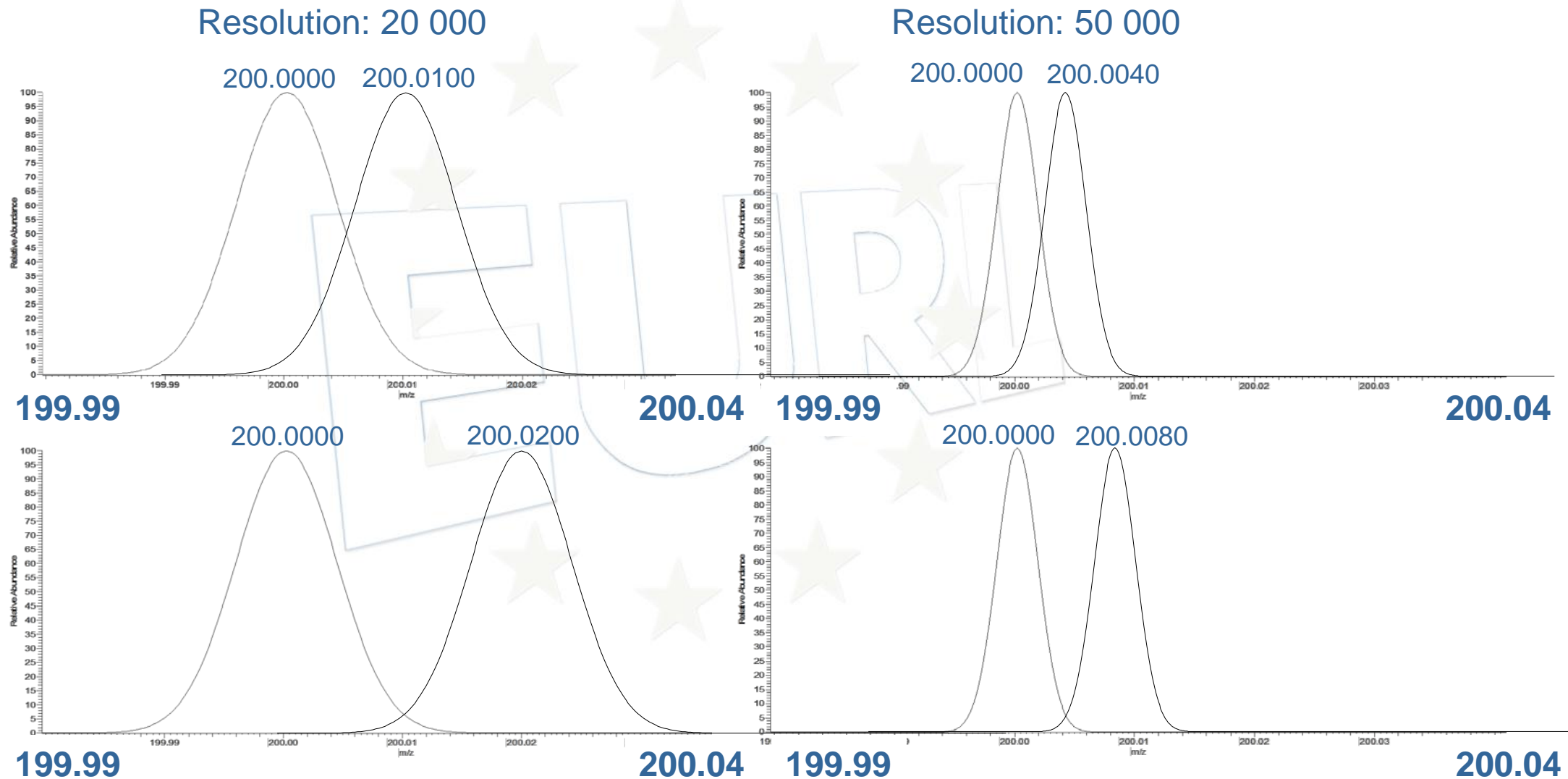

## EUPT Sample of coriander

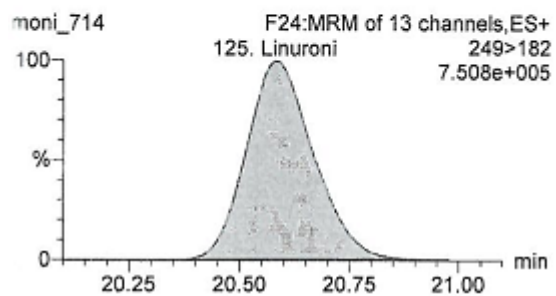
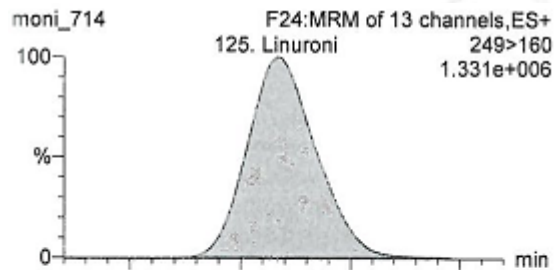

Linuron  
Standard in solvent  
Ion ratio: 1.8



**FALSE NEGATIVE**

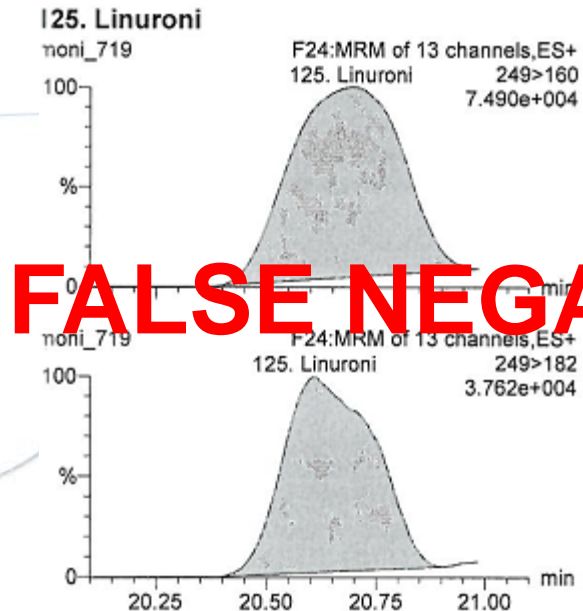

Linuron  
Real sample of coriander  
Ion ratio: 2.4

LC-MS/MS

# LC-QqQ-MS/MS

## Patrón de Fenpropathrin (50 µg kg<sup>-1</sup>)

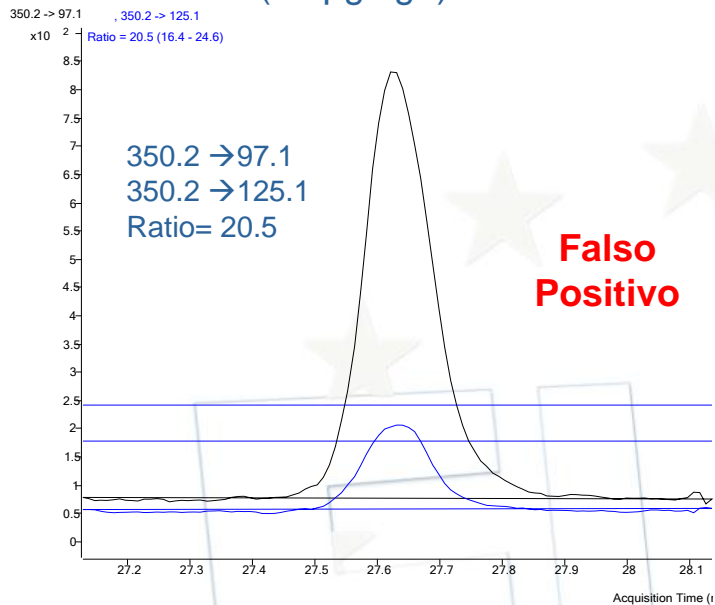

## Real sample Clorpyrifos (48 µg kg<sup>-1</sup>)

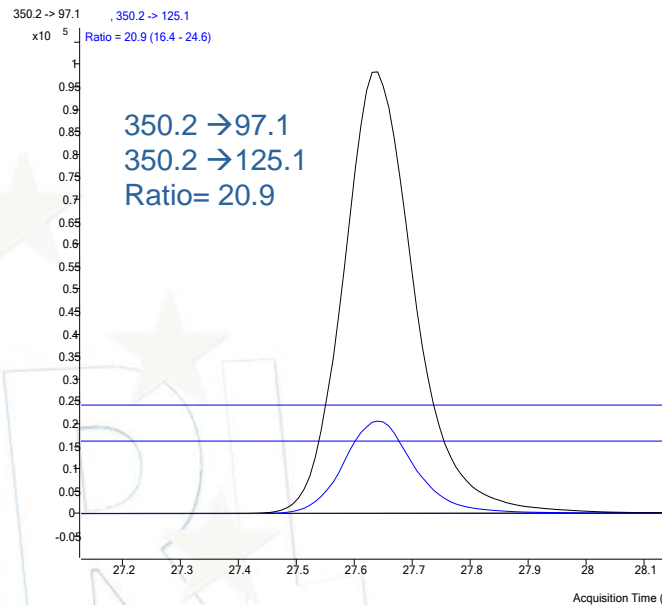

# LC-Orbitrap-MS

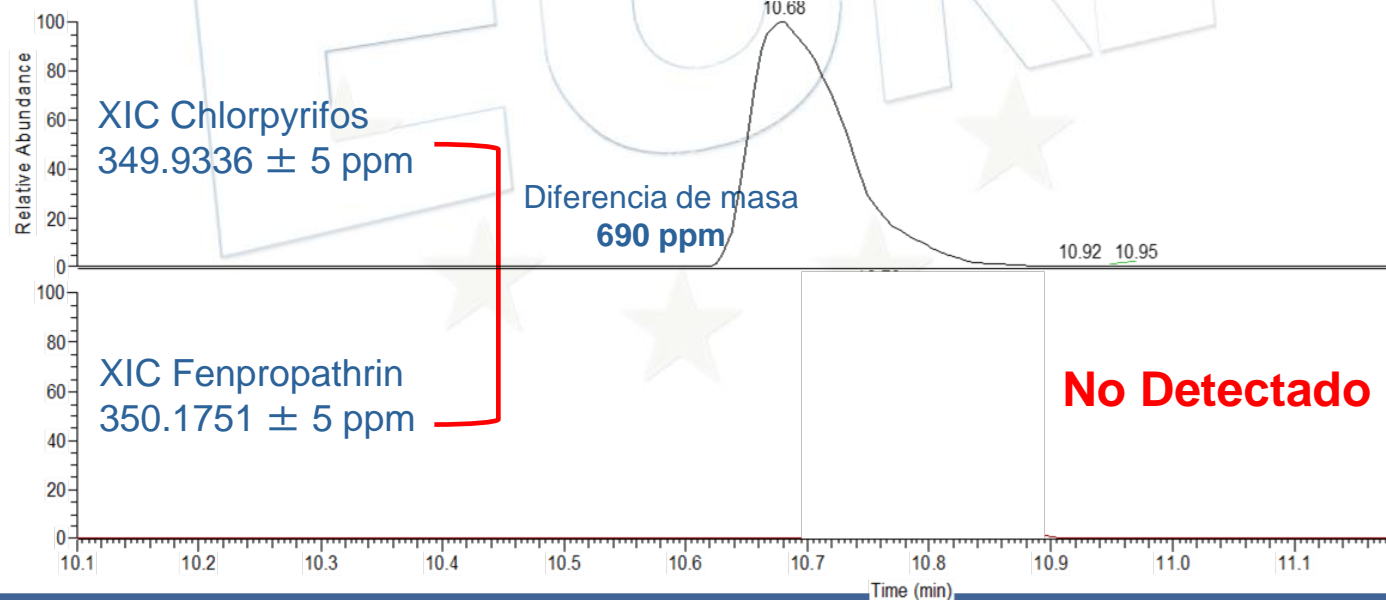



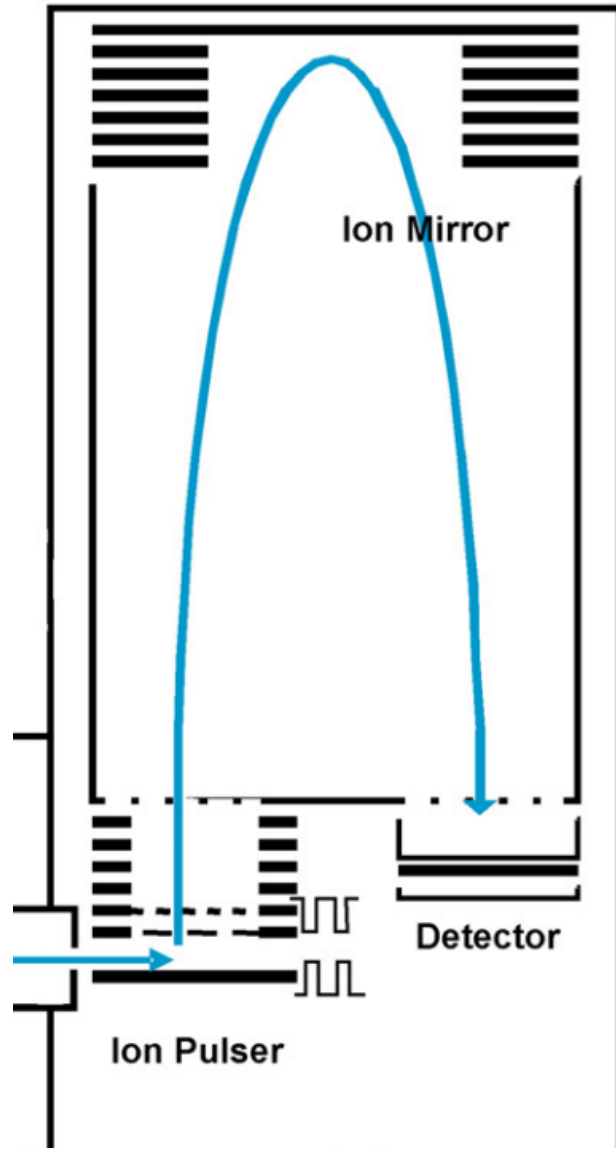

Time of flight

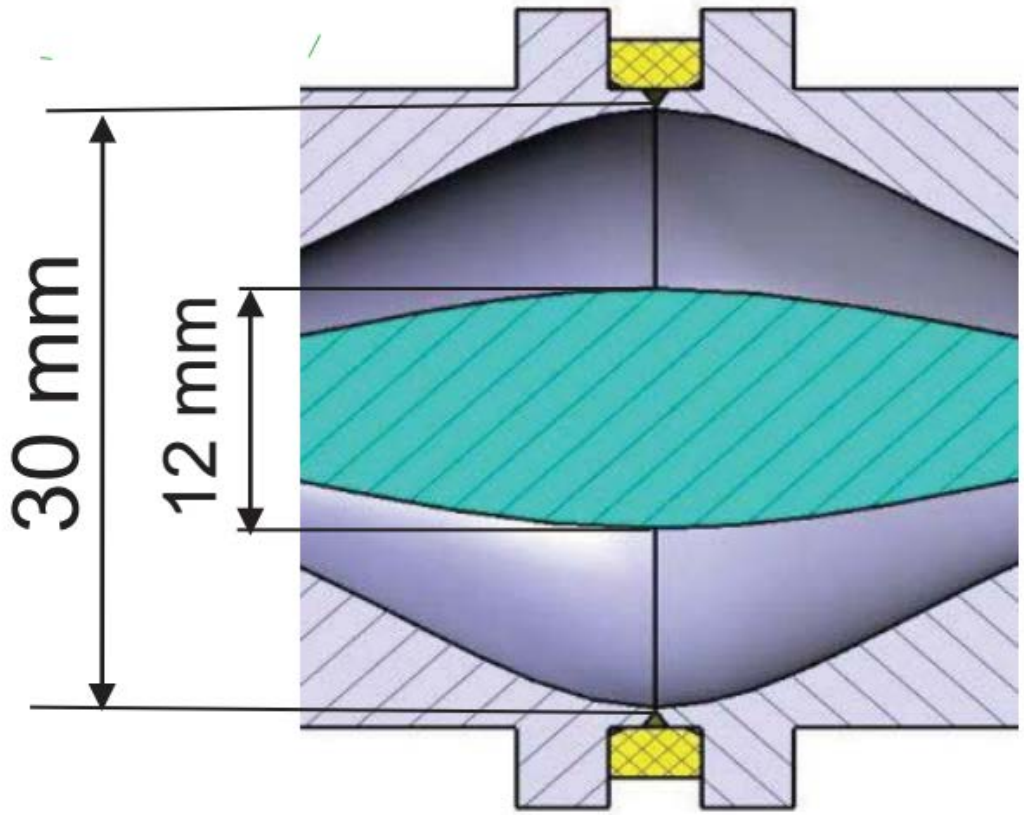

Orbitrap

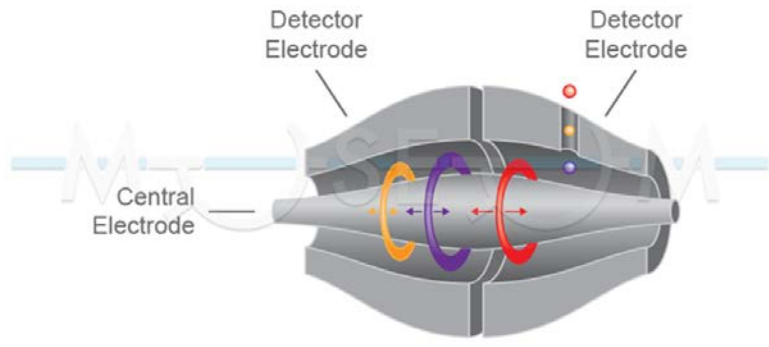

# Challenges and future directions in LC-MS-based multiclass method development for the quantification of food contaminants

David Steiner, Alexandra Malachová, Michael Sulyok, Rudolf Krška

*Analytical and Bioanalytical Chemistry (2021) 413:25–34*

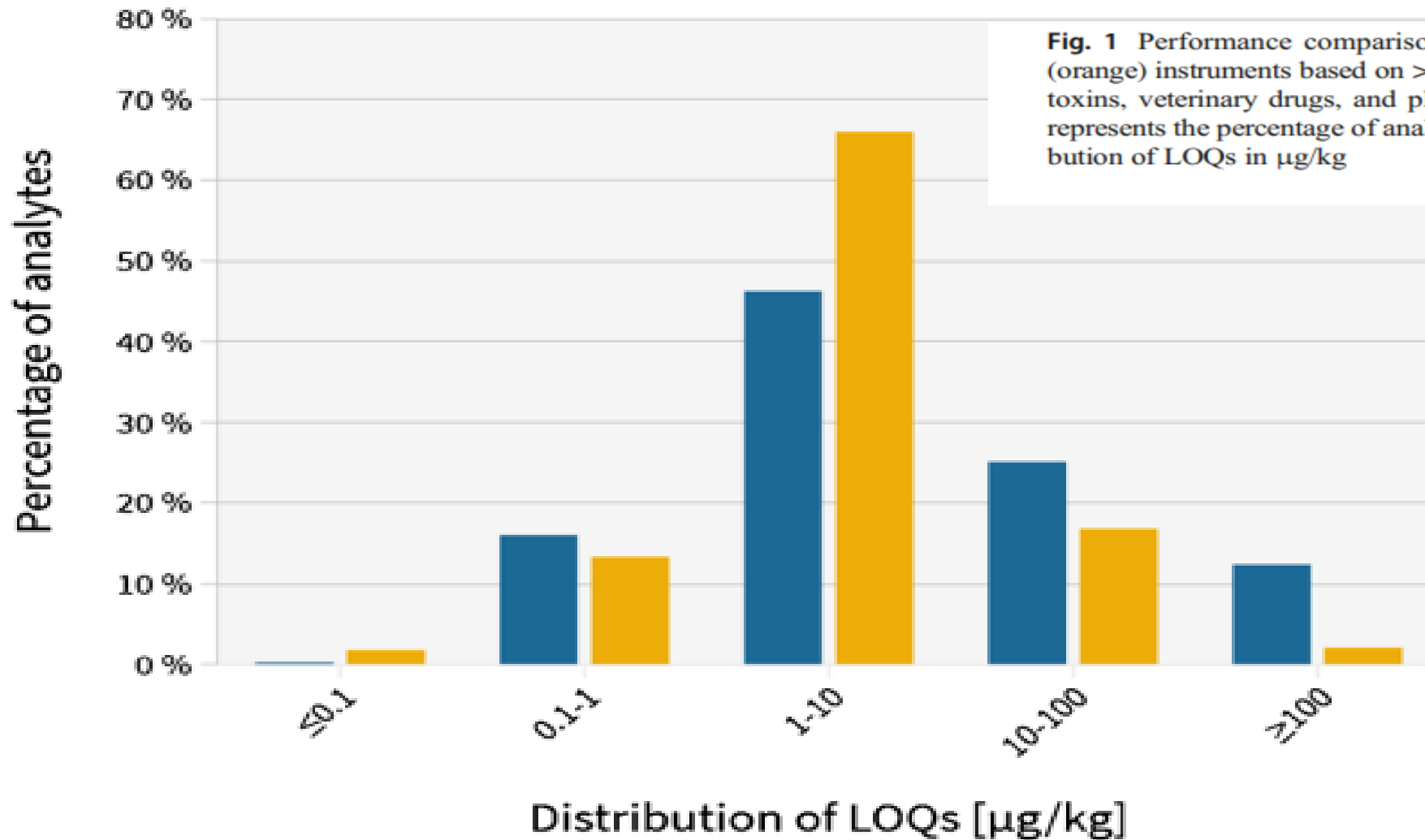

**Fig. 1** Performance comparison between HRMS (blue) and MS/MS (orange) instruments based on > 3800 LOQ results for pesticides, mycotoxins, veterinary drugs, and plant toxins [22, 24, 26, 30]. The y-axis represents the percentage of analytes, and the x-axis represents the distribution of LOQs in  $\mu\text{g}/\text{kg}$

# AIF

Identified in full compliance with the EU SANTE guideline criteria



**Bell Pepper**  
246 pesticides



**Orange**  
246 pesticides



**Onion**  
246 pesticides

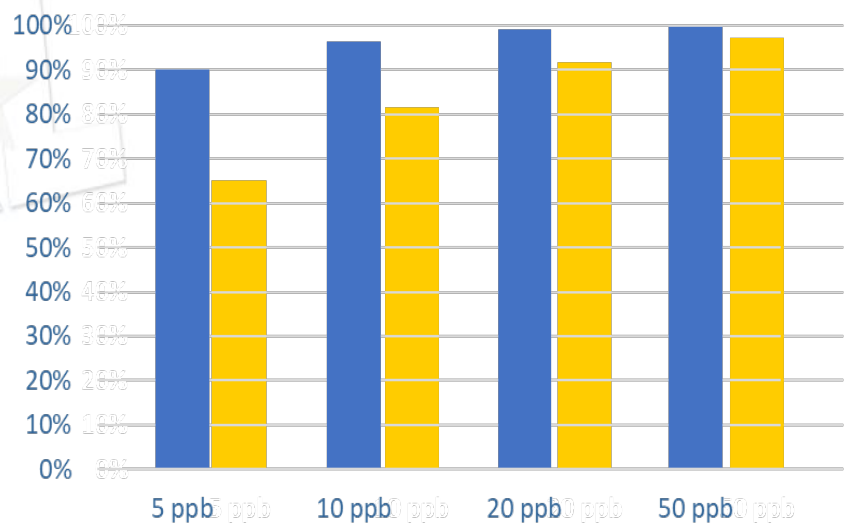
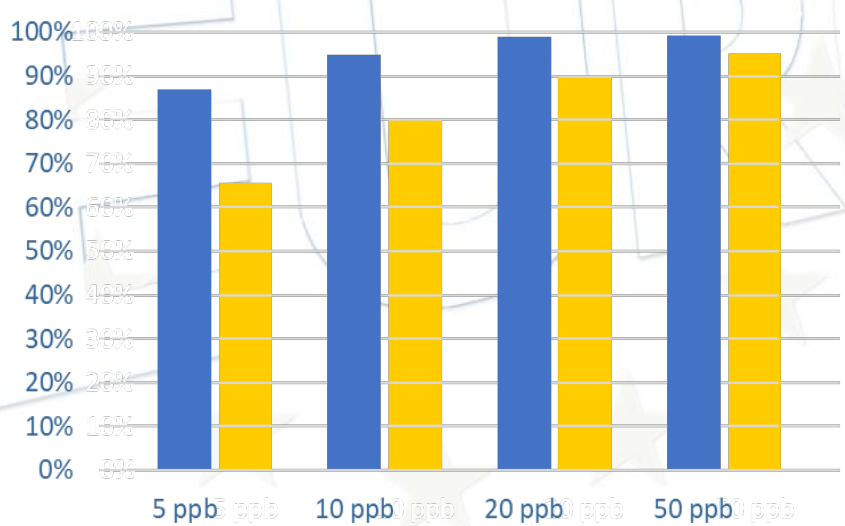
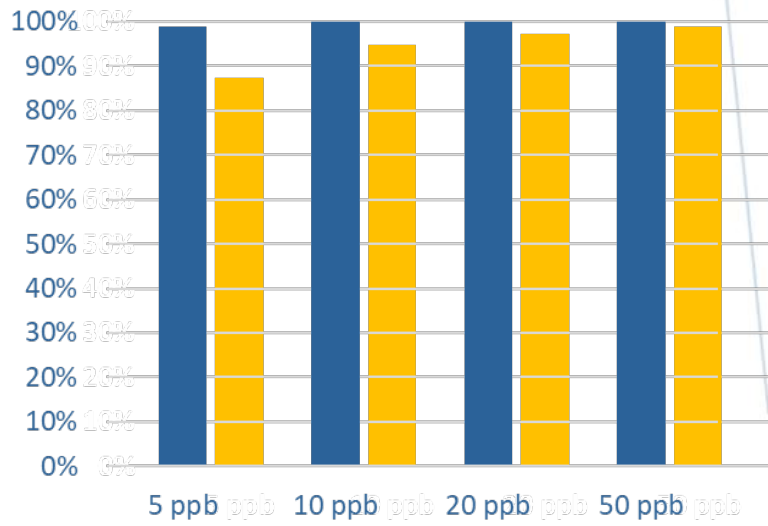

■ DETECTED

■ IDENTIFIED

# MS vs MS/MS in LC-HRMS



Broccoli

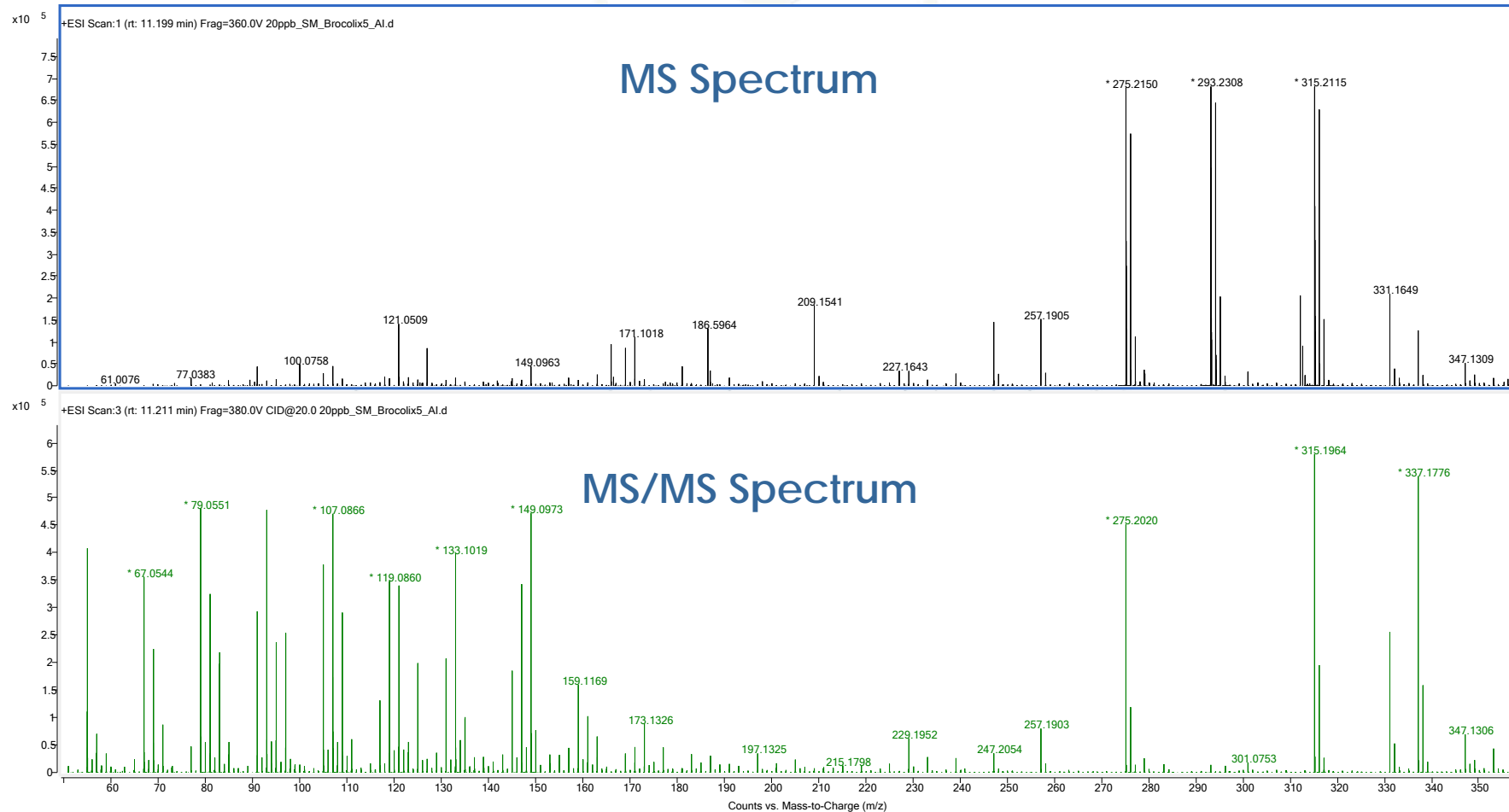

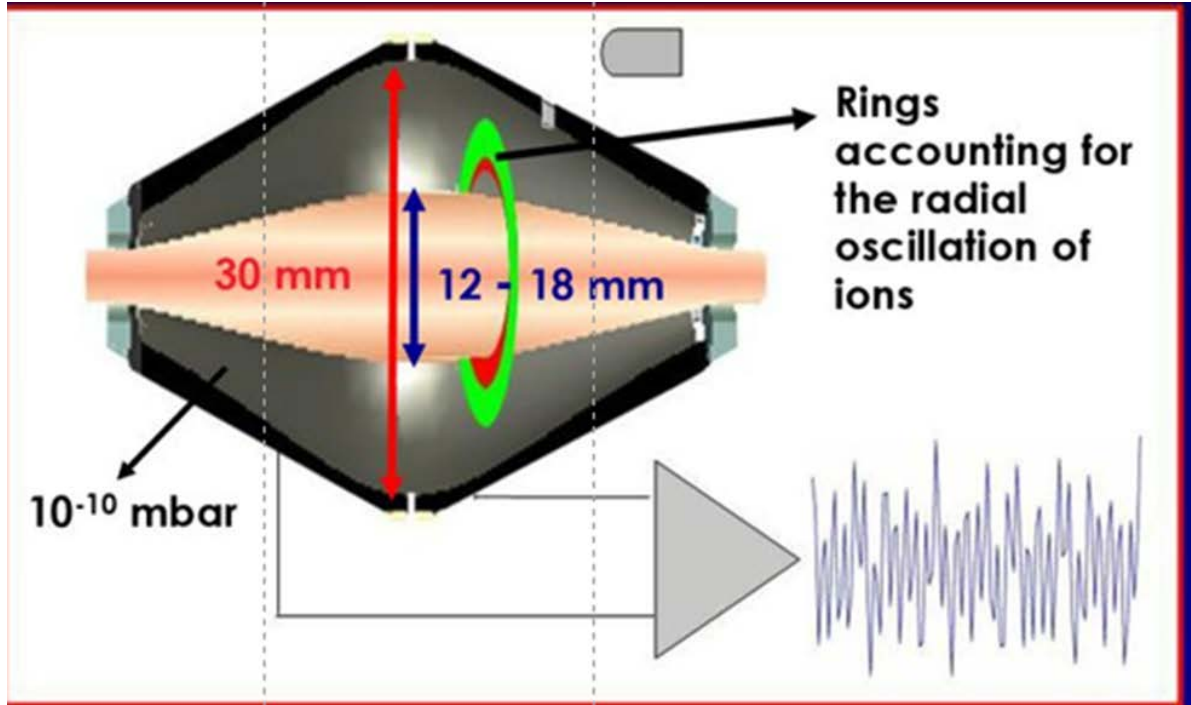
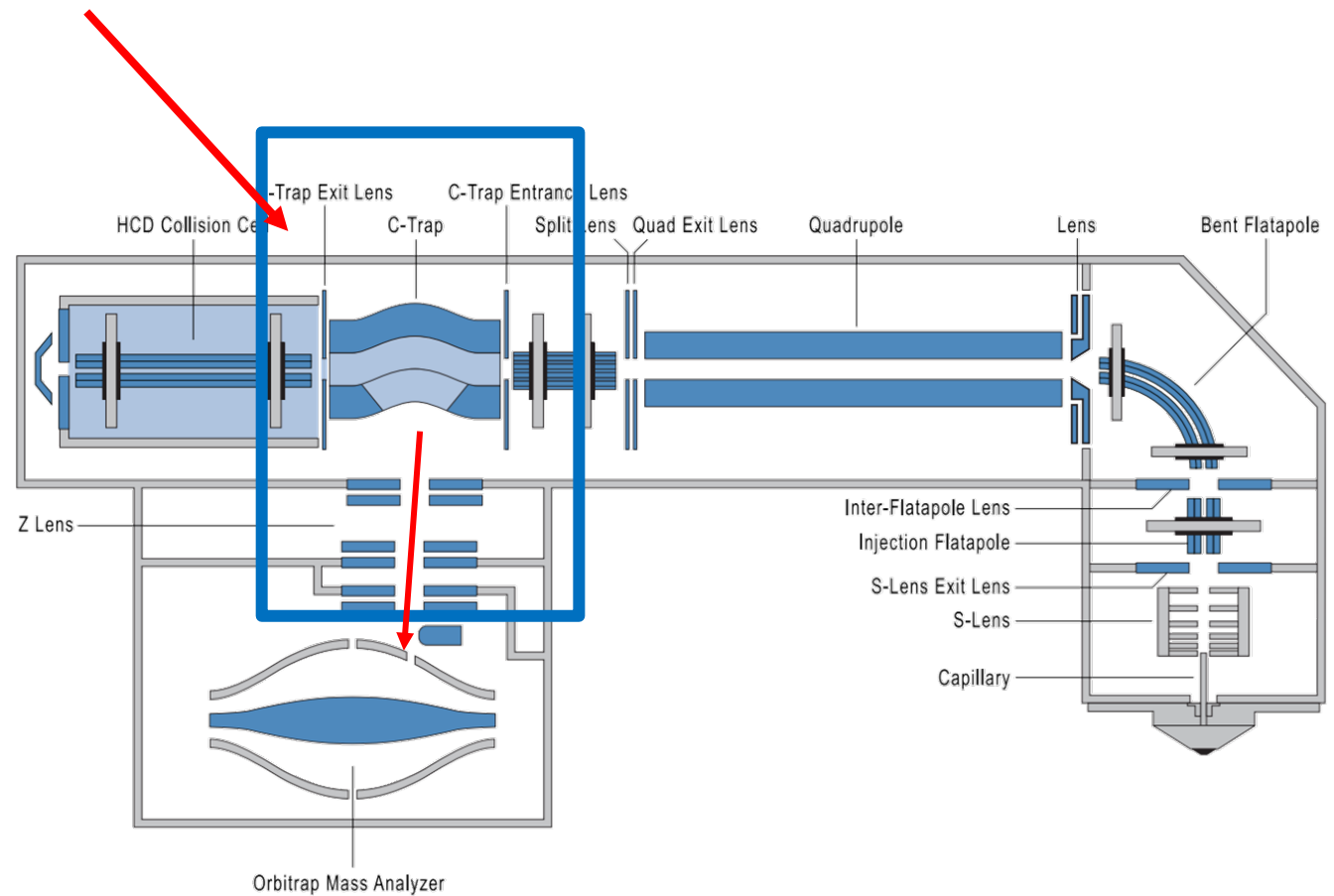

## ... and Why is Duty cycle important?

### What is duty cycle?

- % of ions injected into the TOF
- Typically, ~5-25%

Dependent on

- Fragment mass



### Why is duty cycle not 100%

- Ion losses occur when combining:

Pulsed measurement technique

- TOF

Continuous ion beam

- Quadrupole

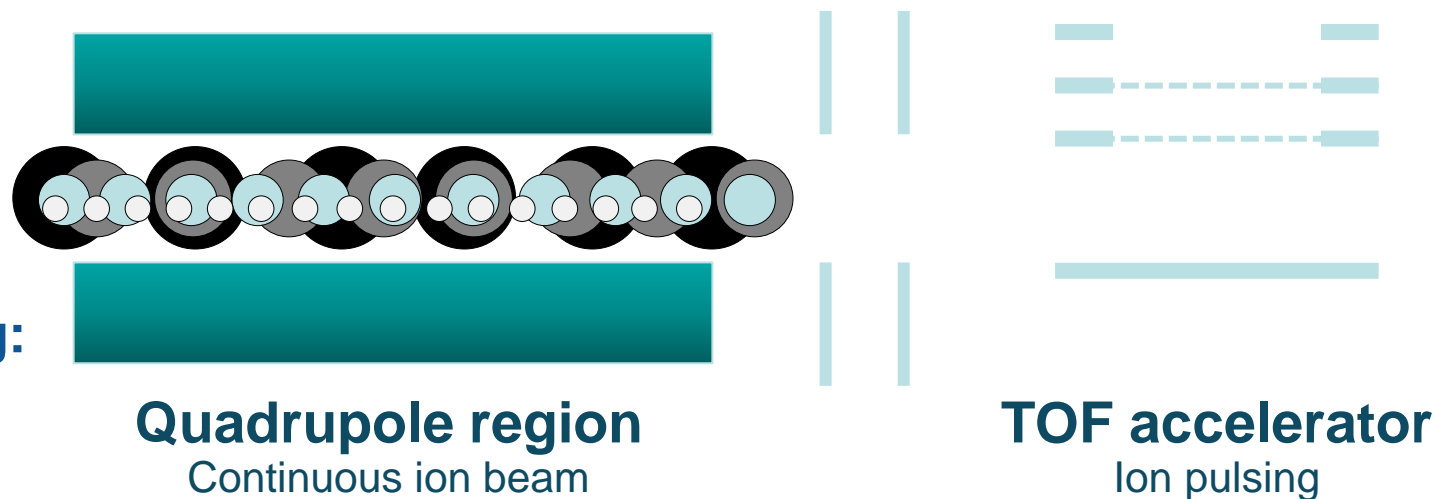

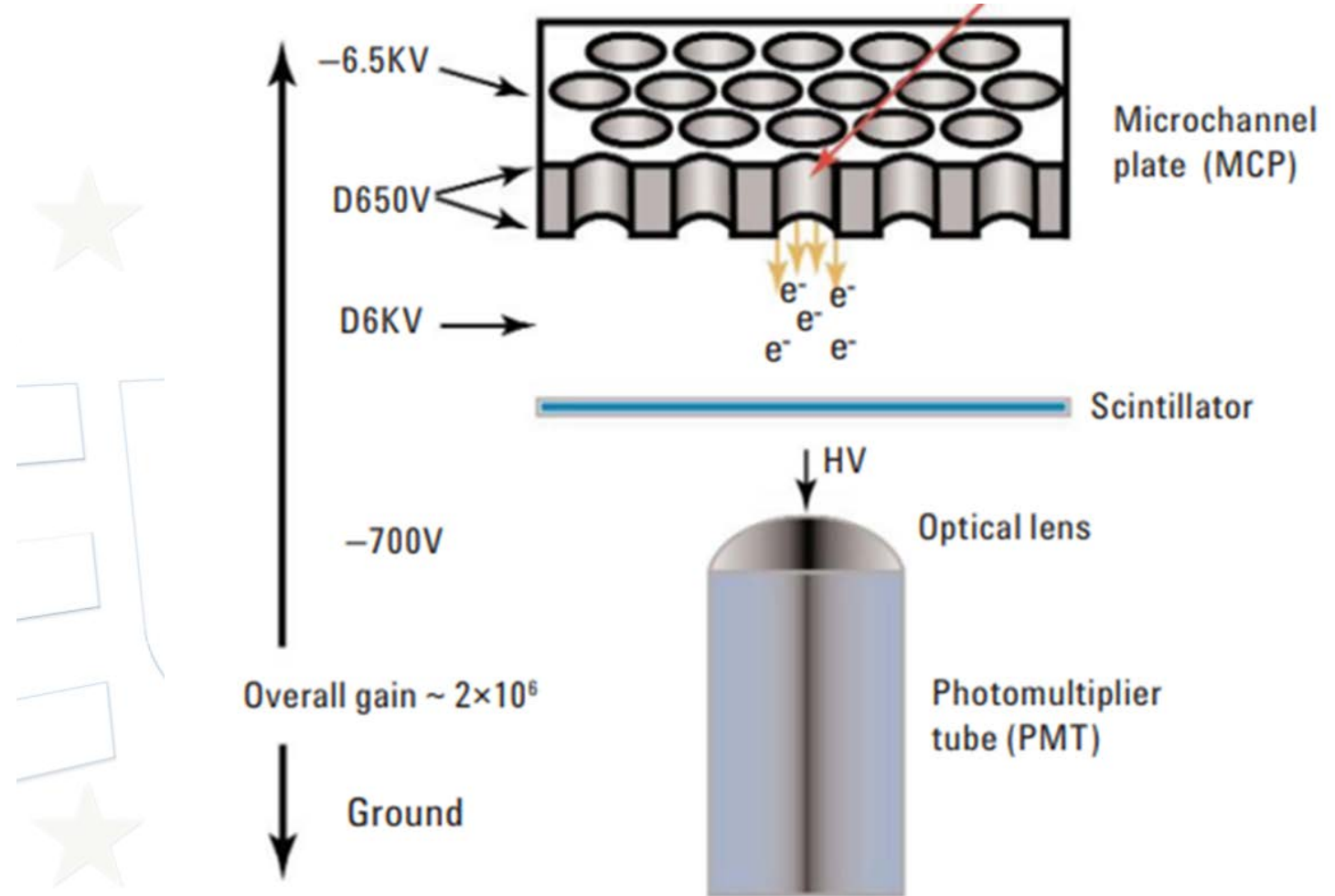
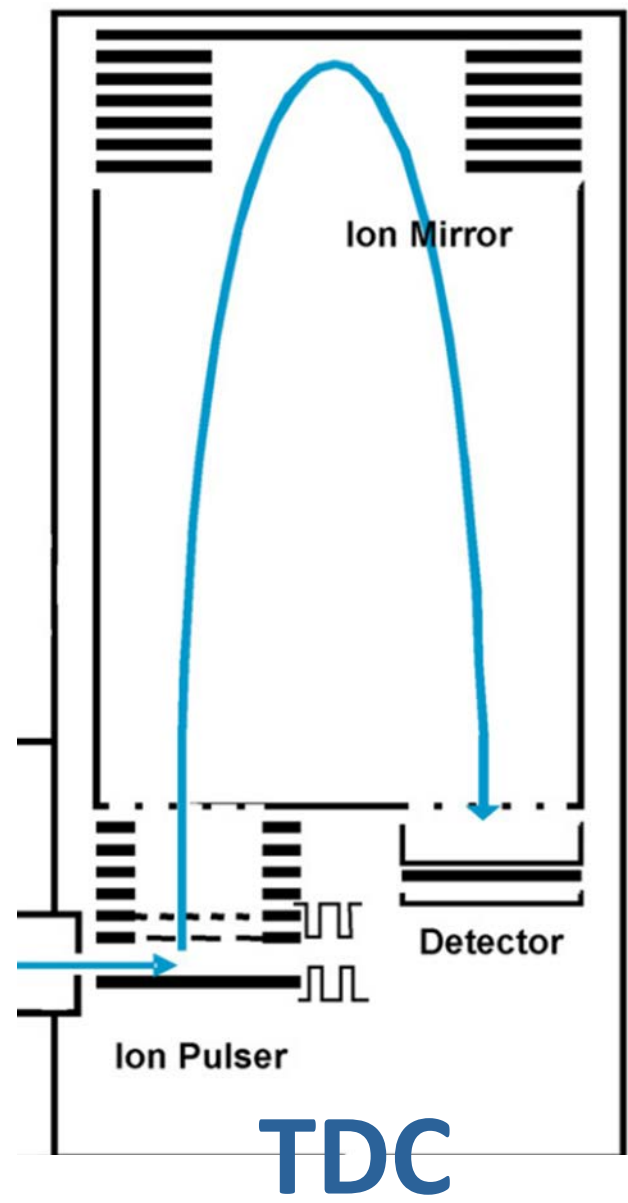
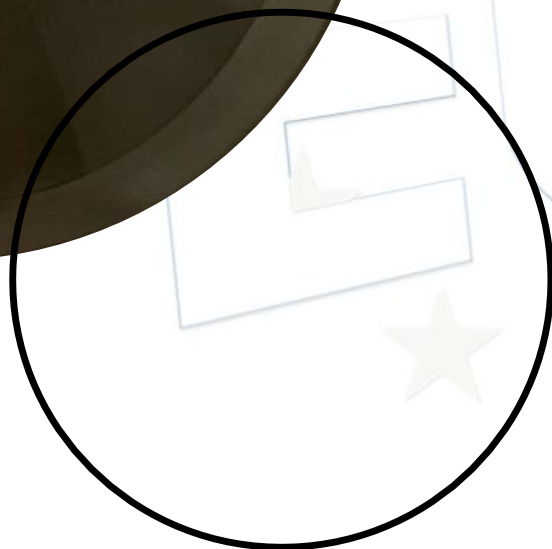
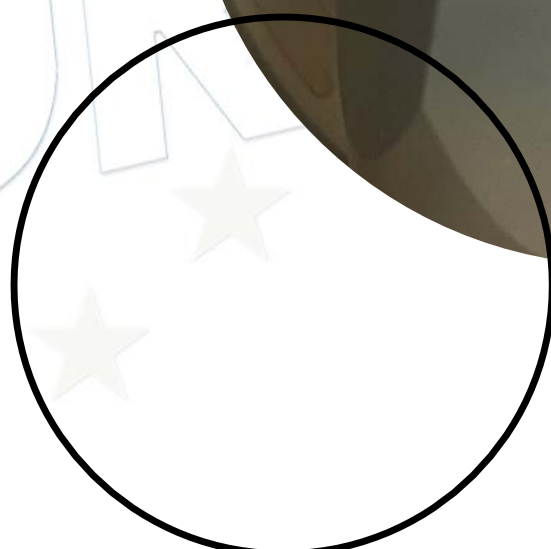
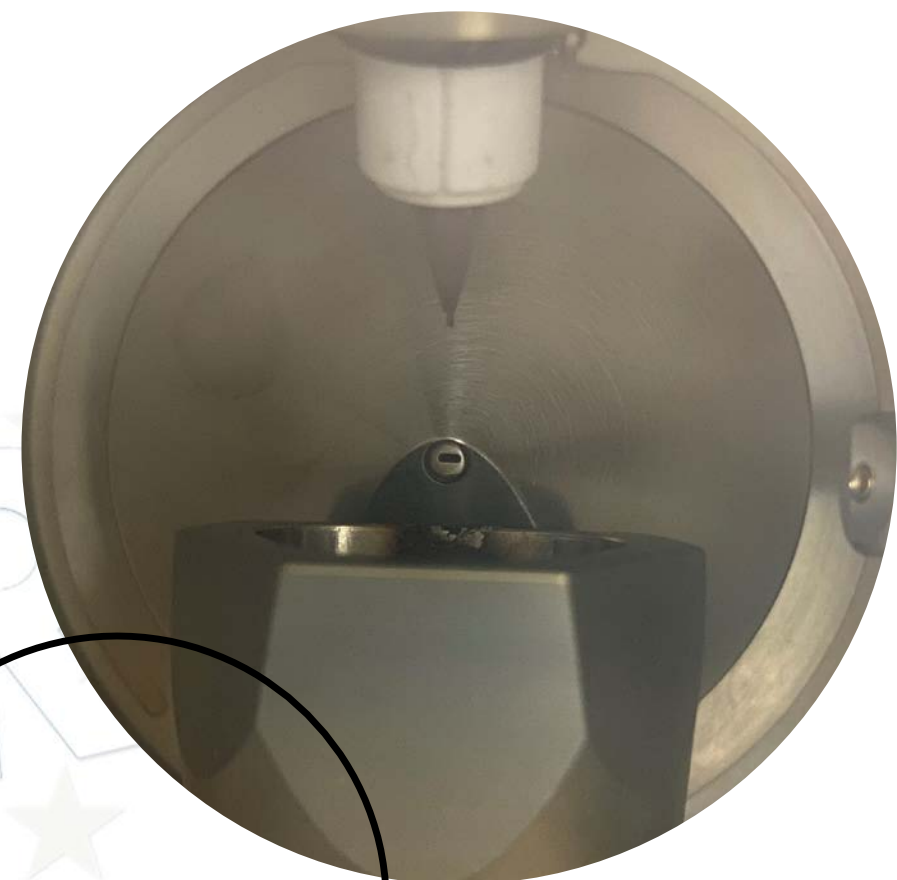

Figure 2. TOF detector with potentials shown for positive ion operation.



**Q Exactive™ Focus**



**TSQ Altis™**



# Saturation

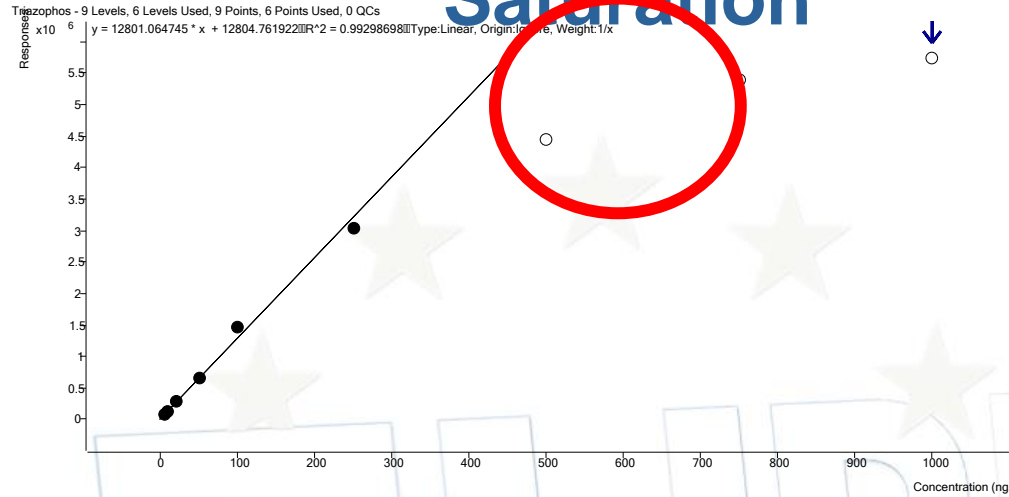

Triazophos

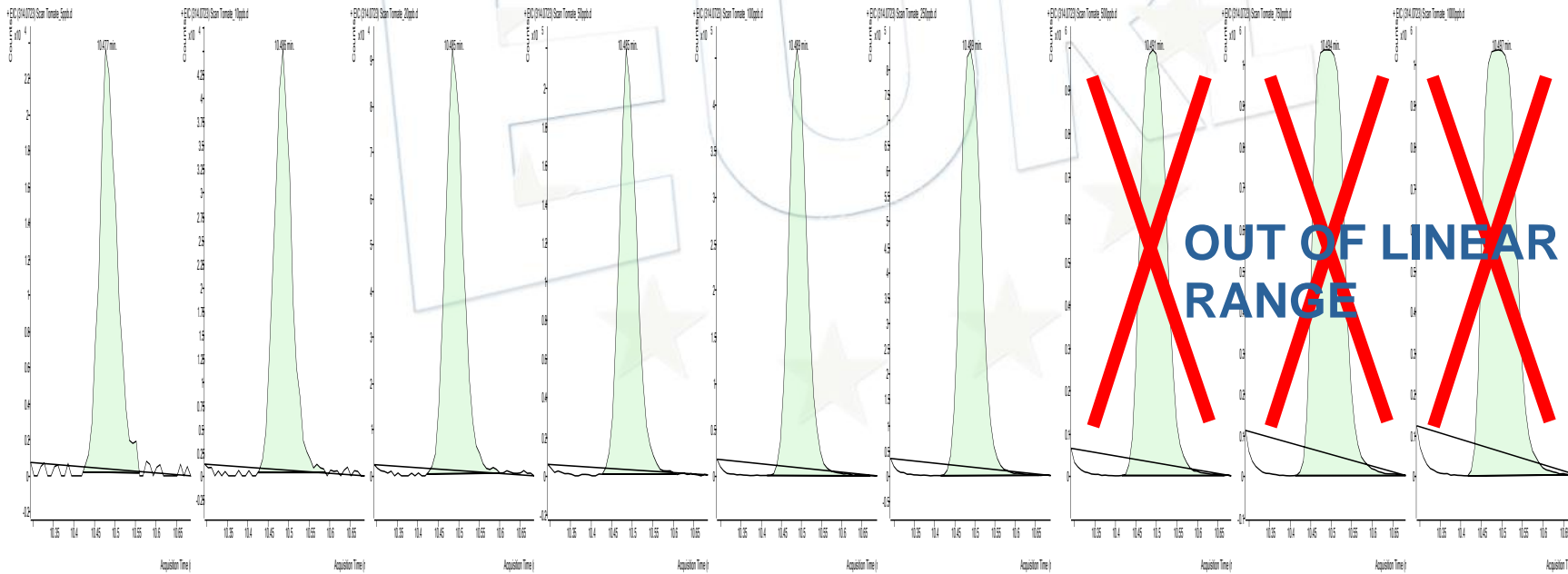

# High-resolution mass spectrometry

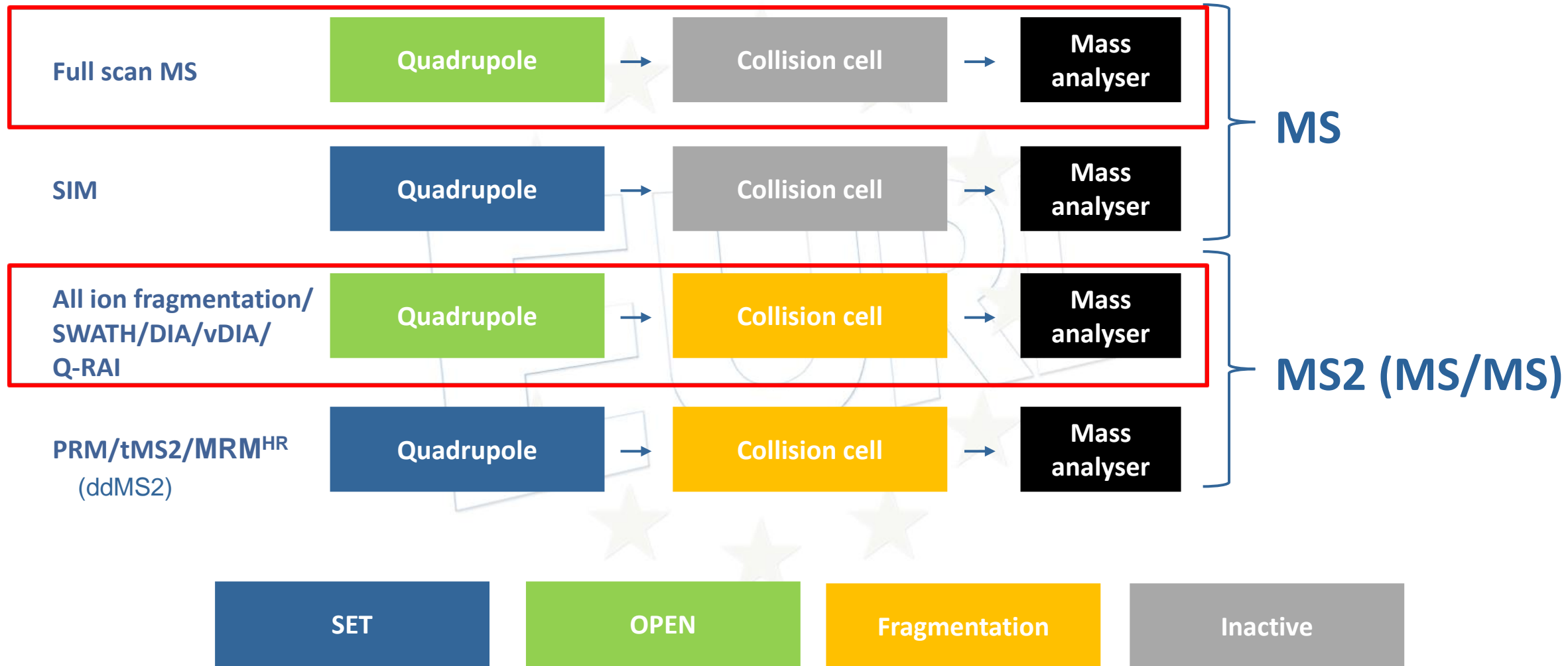

# Co-extracted Matrix Components LC-HR-MS

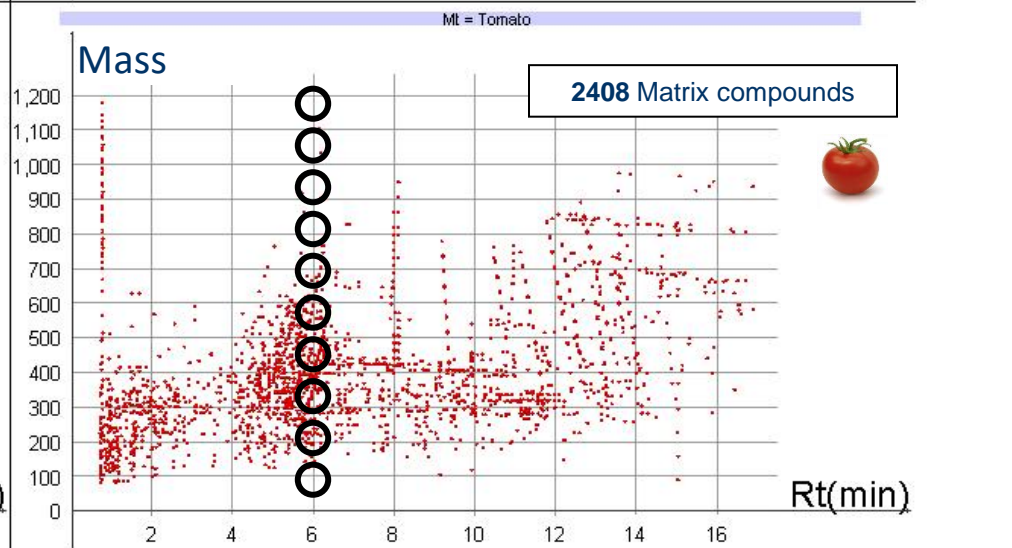
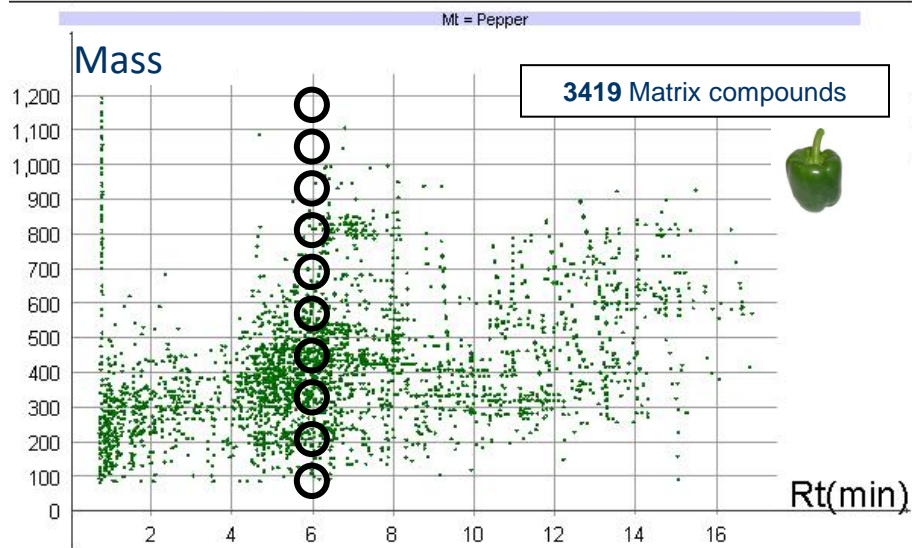
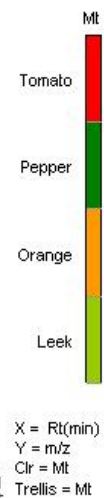
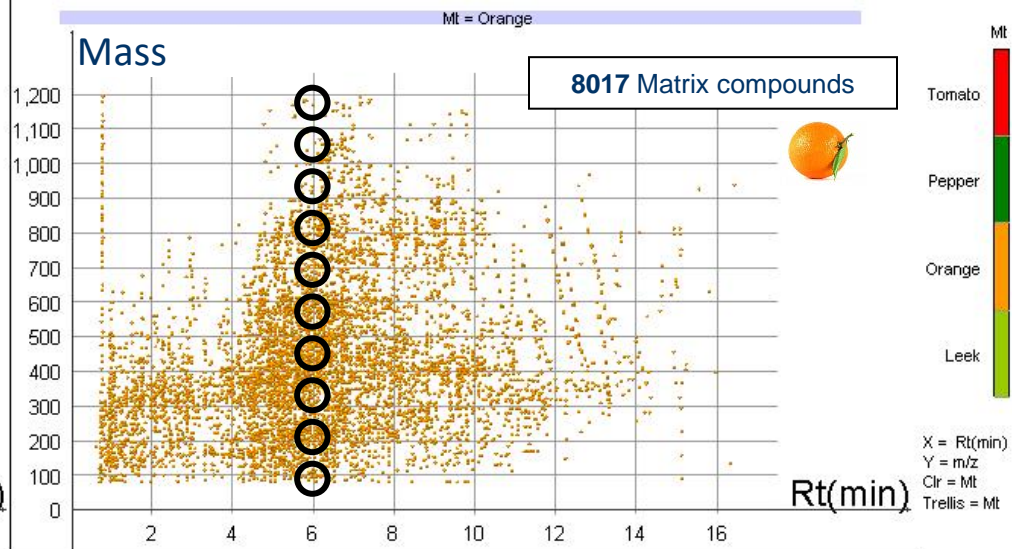
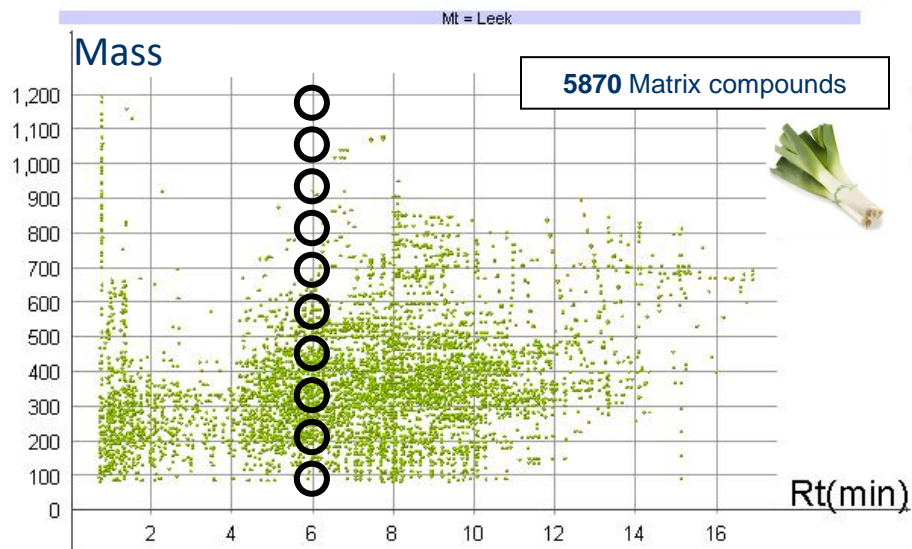

Miner 3D Enterprise

Compounds with absolute height  $\geq 10000$  counts

Injected: 1g sample/mL extract

## ZenoTOF: SWATH windows testing

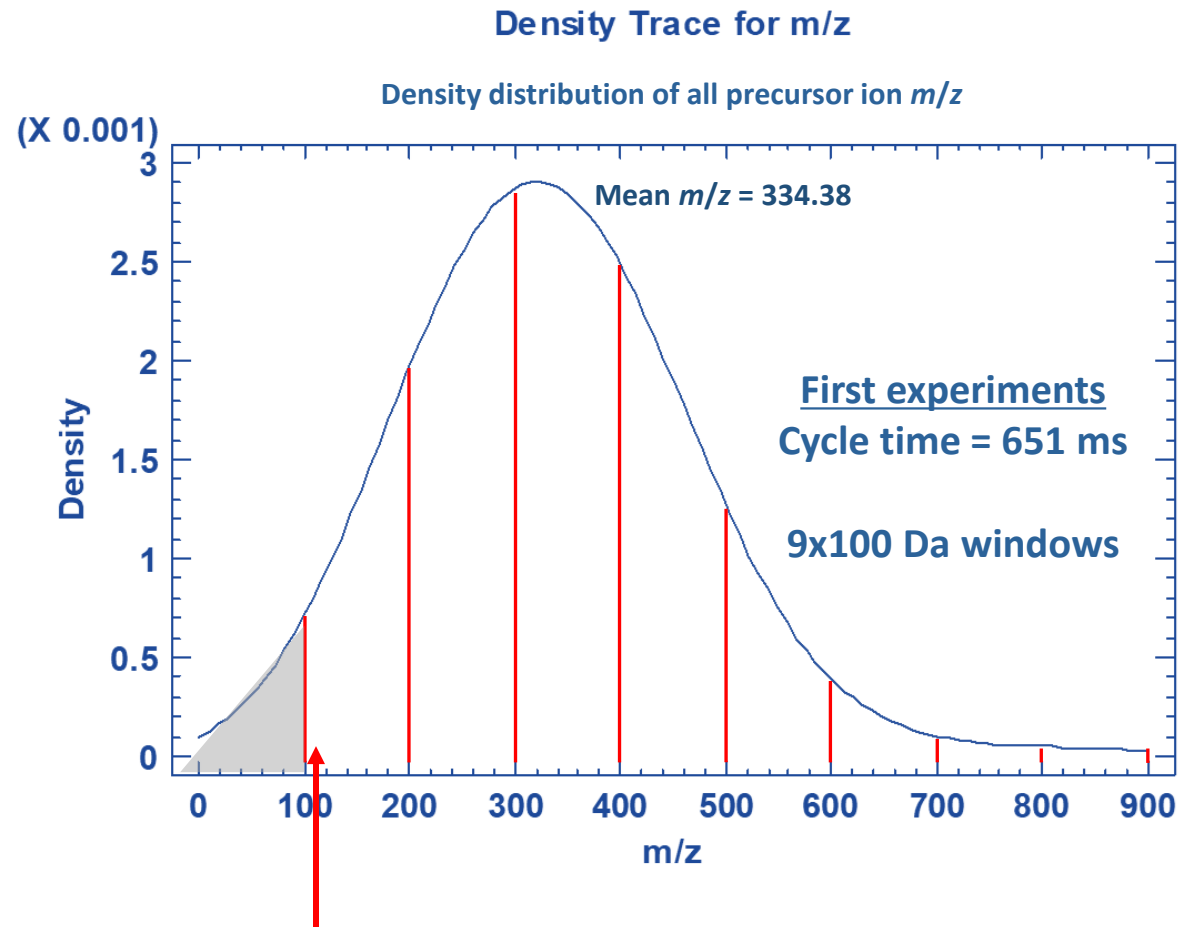

First precursor ion ( $m/z$  122)

## ZenoTOF: SWATH windows testing

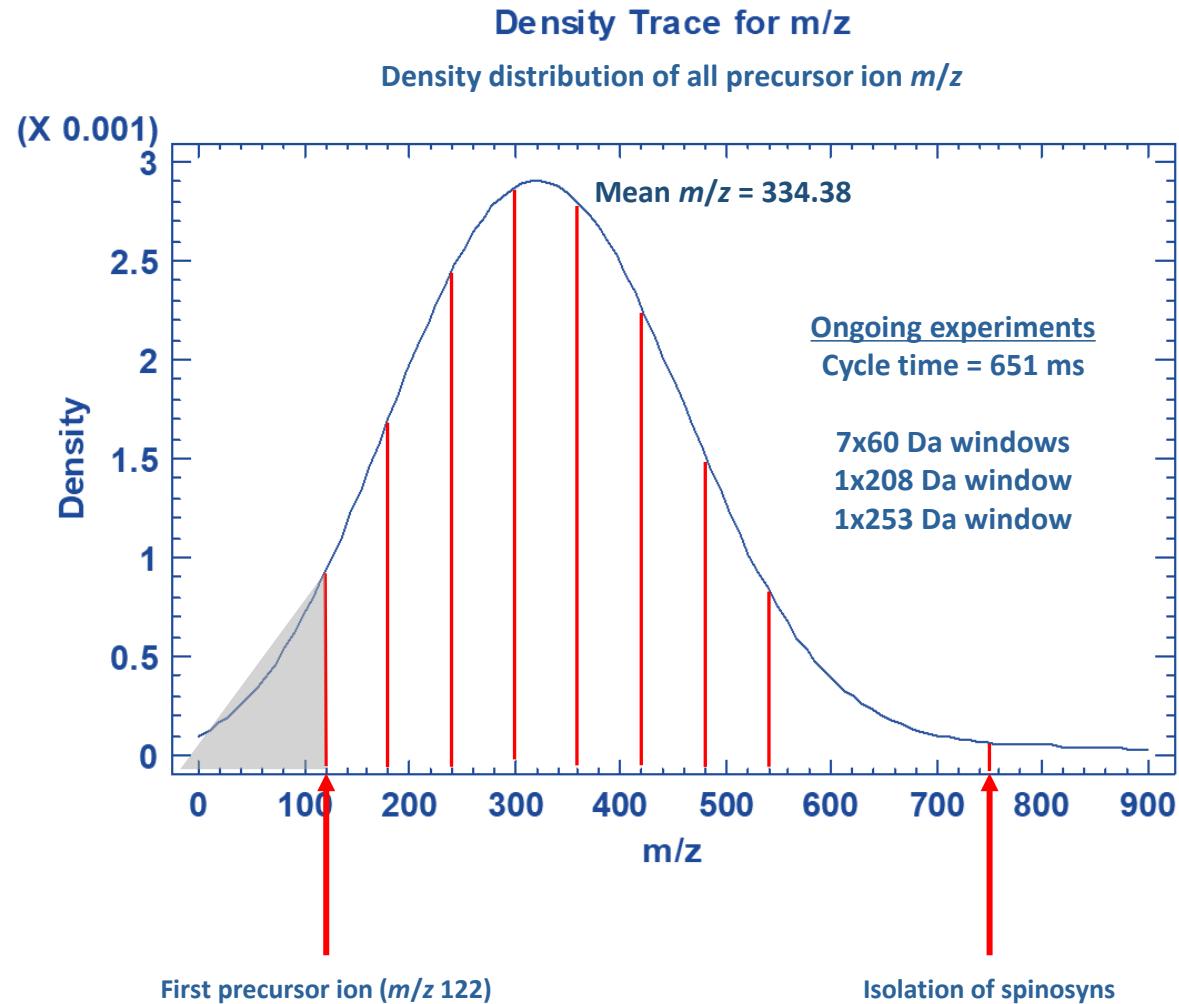

# EVALUATION OF THE NUMBER OF ISOLATION WINDOWS



Fragment Mass error  
Tebufenozide at 5 µg/kg

## LC-QTOF-MS

SWATH 1 window (850 Da)

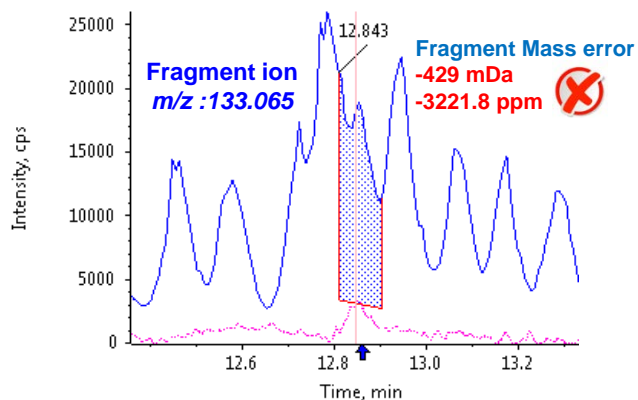

SWATH 8 windows (108 Da)

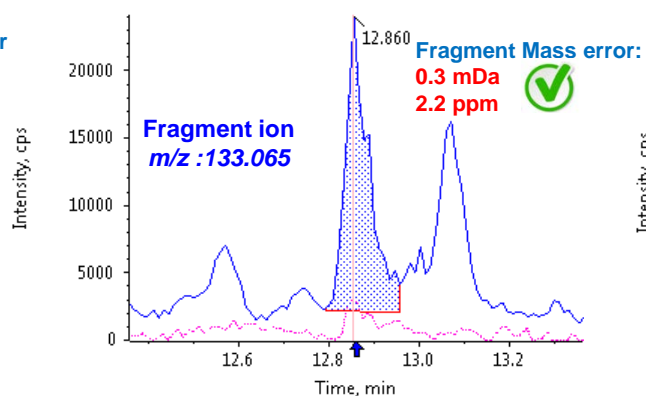

SWATH 20 windows (44 Da)

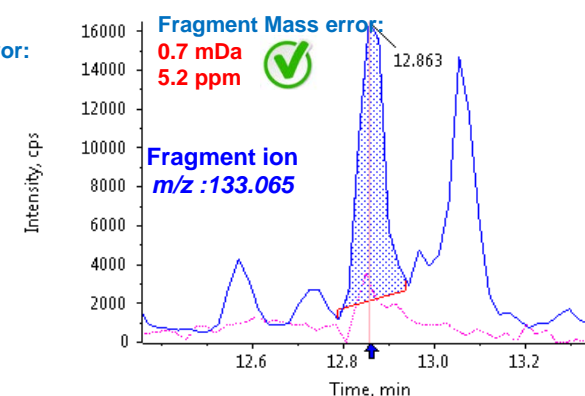

MS/MS Spectrum

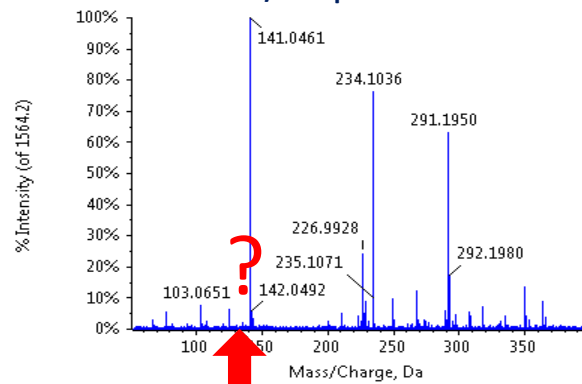

MS/MS Spectrum

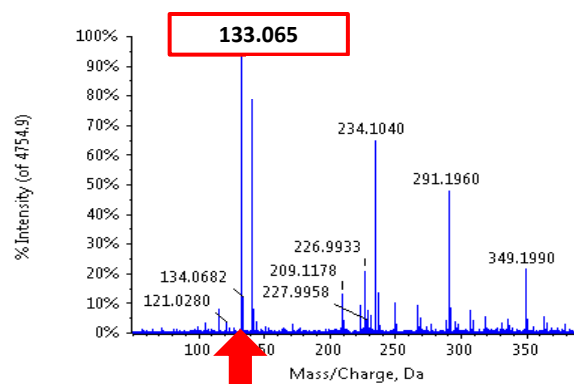

MS/MS Spectrum

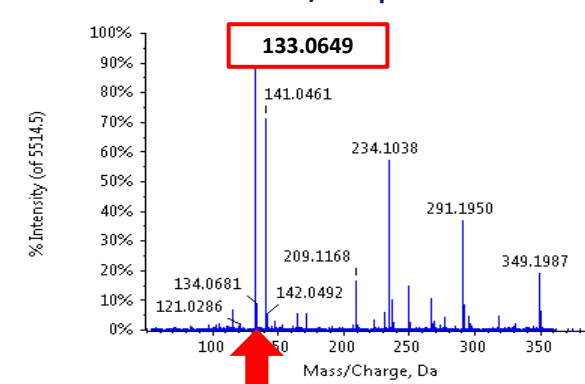

# SWATH Sciex X500R QToF

- Full scan MS (scumulation time 200m ms)
- MS<sup>2</sup> (scumulation time 50m ms)

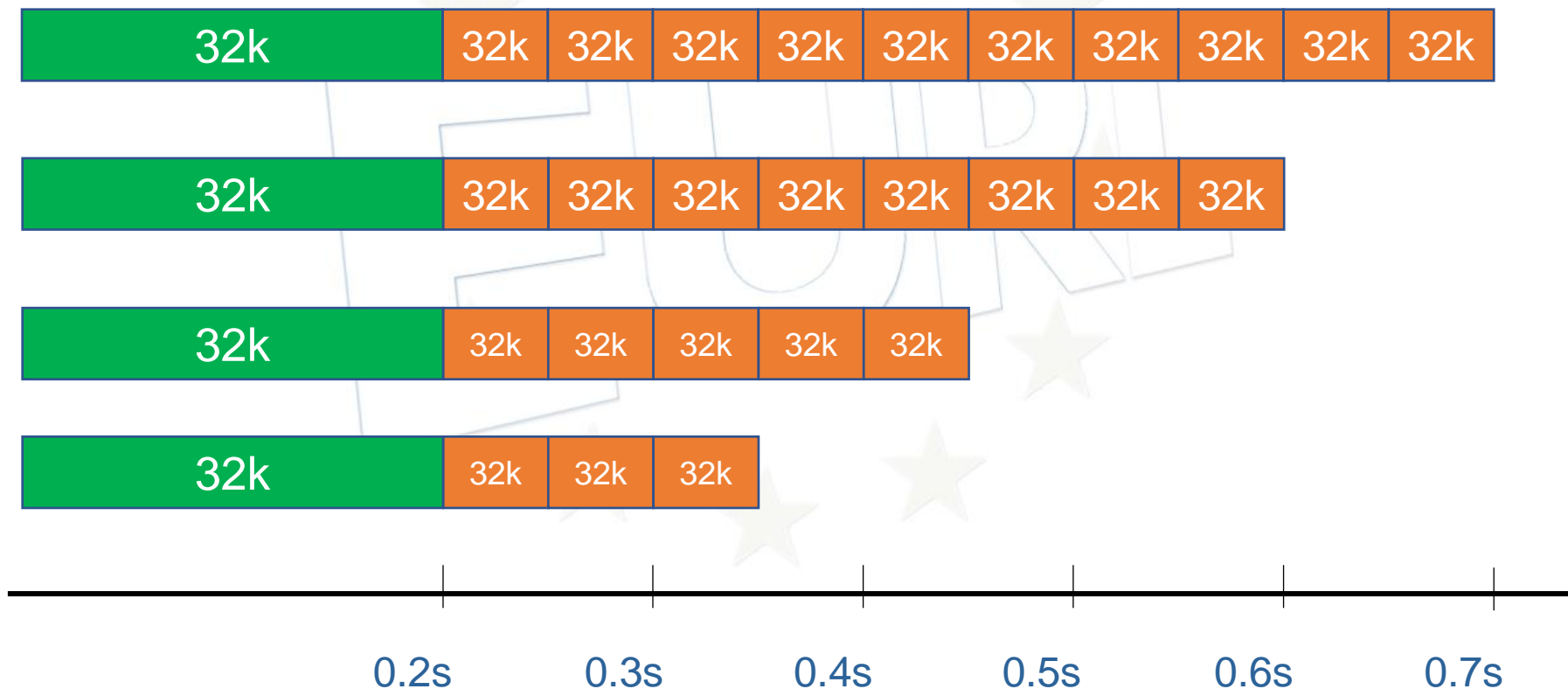

# Acetamiprid in Aubergine at 0.01 mg/kg

1 window

● Aubergine\_10ppb\_1W - A...2), (sample Index: 17)  
 Area: 1.909e3, Height: 4.594e2, RT: 6.24 min

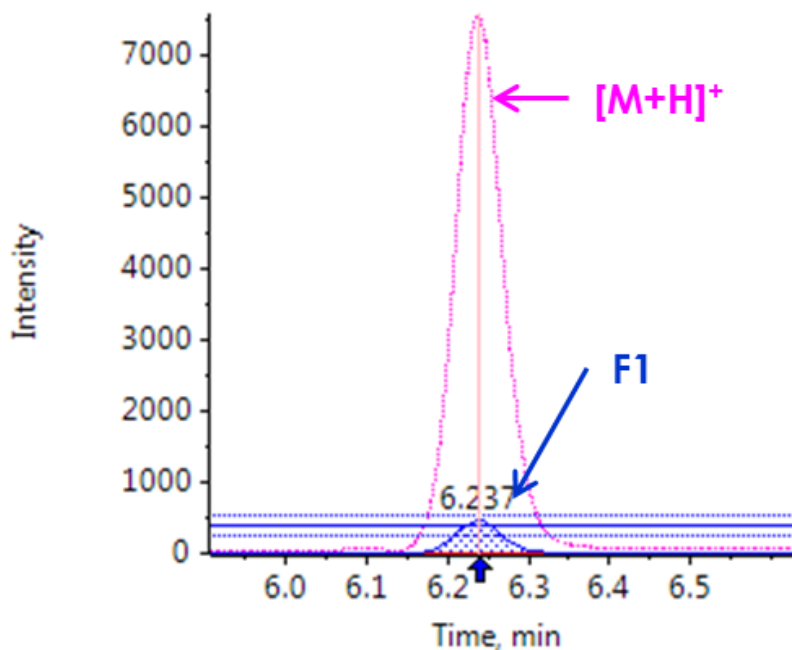

▼ Peak Details

Precursor m/z	Retention Time (min)	Ion Ratio
223.075	6.24	0.0599

Fragment area: 1909 counts

10 windows

● Aubergine\_10ppb\_10W - ...f2), (sample Index: 9)  
 Area: 7.614e3, Height: 1.258e3, RT: 6.24 min

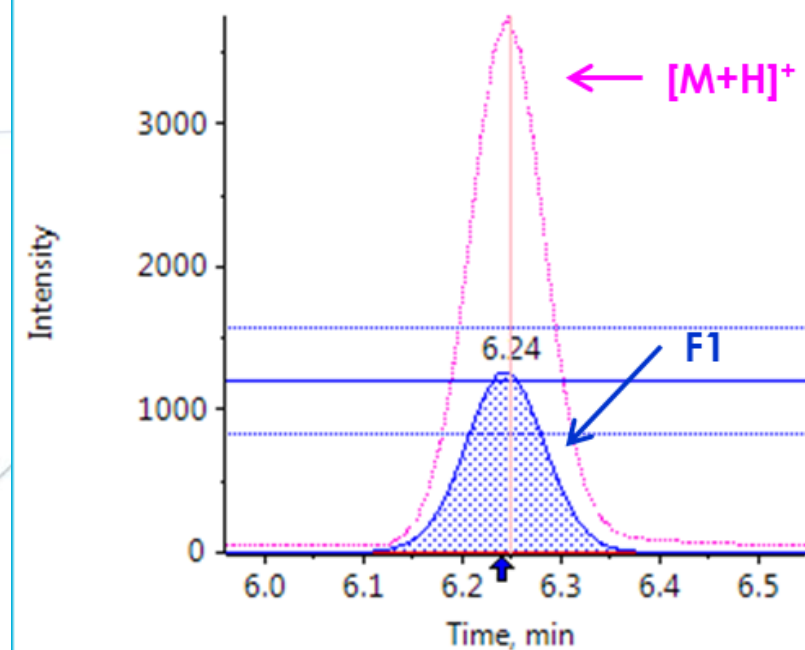

▼ Peak Details

Precursor m/z	Retention Time (min)	Ion Ratio
223.075	6.24	0.3633

Fragment area: 7614 counts



Standard Orbitrap

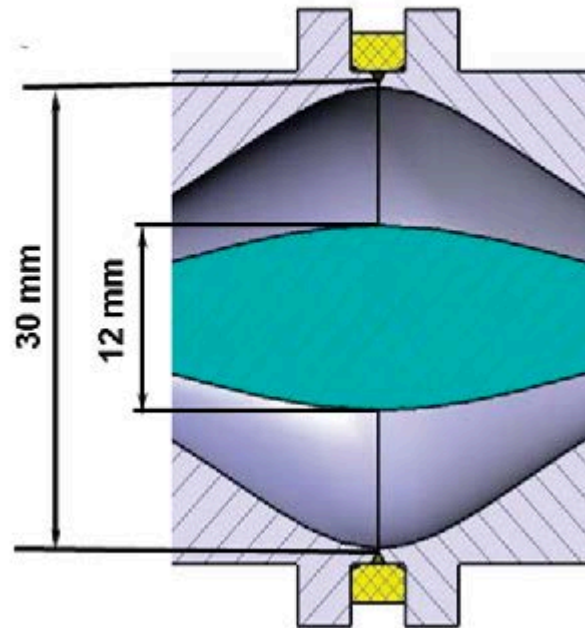

High Field Orbitrap

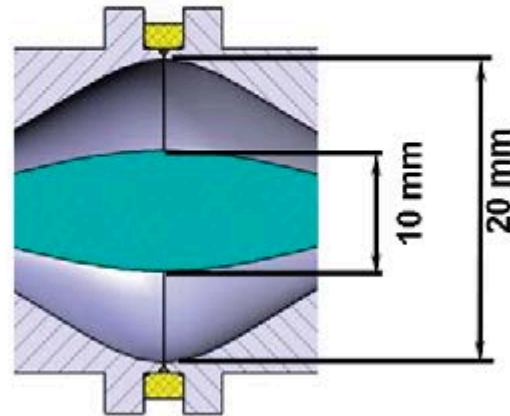

# LC-HR-ESI-MS/MS

## ACQUISITION WORKFLOWS



~~All Ion  
Fragmentation or  
NOT AIF?  
That is the question~~

Data acquisition mode	MS	MS <sup>2</sup>
Targeted	SIM	PRM, tMS <sup>2</sup> , MRM <sup>HR</sup>
Non-targeted	Full scan	DDA (ddMS <sup>2</sup> , IDA) or DIA (AIF, vDIA, SWATH <sup>®</sup> )

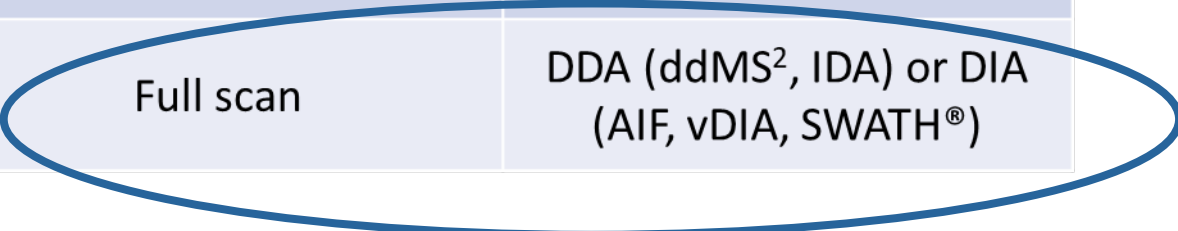

# High-resolution mass spectrometry

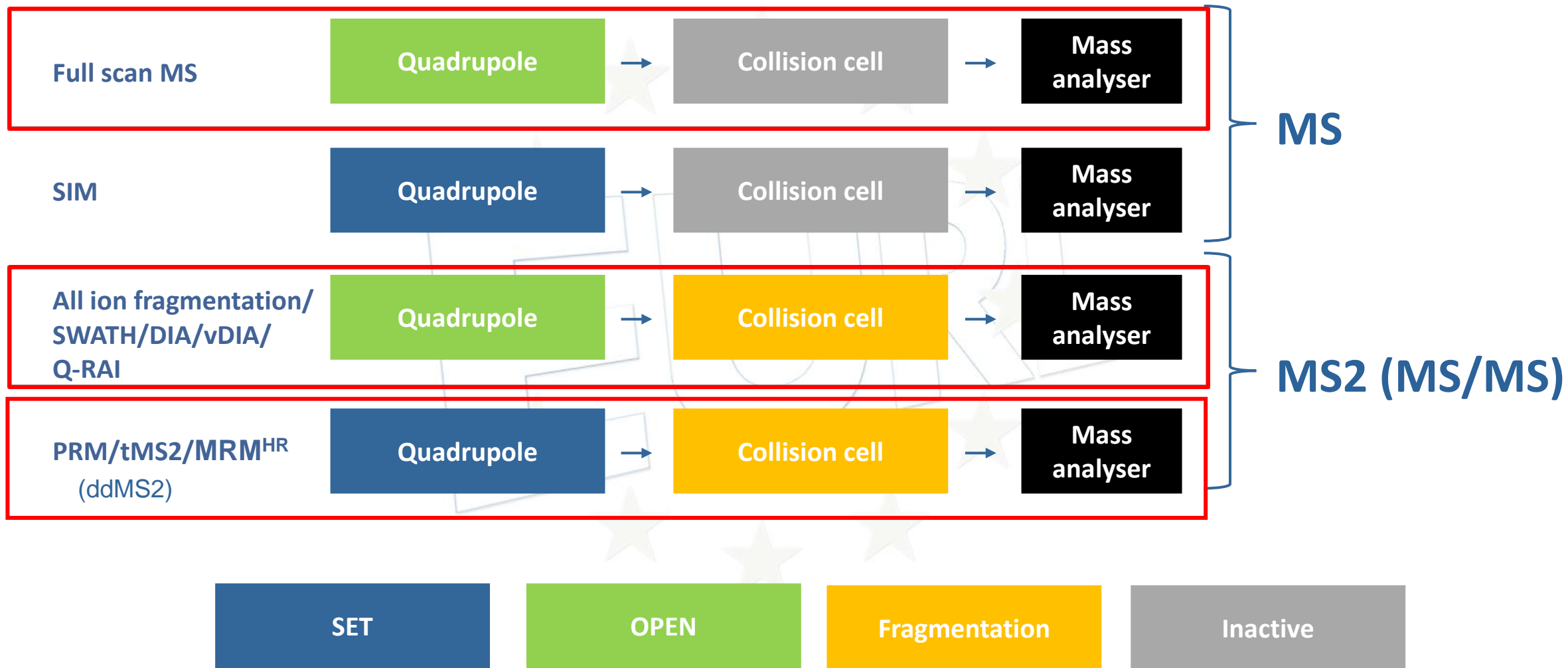

Standard Orbitrap

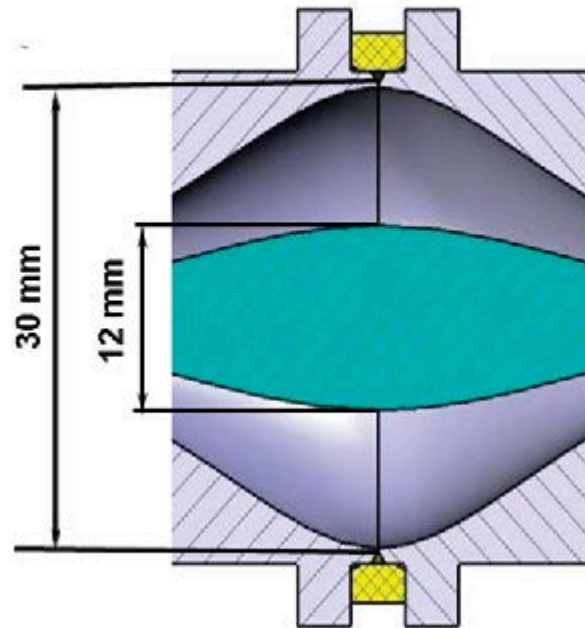

High Field Orbitrap

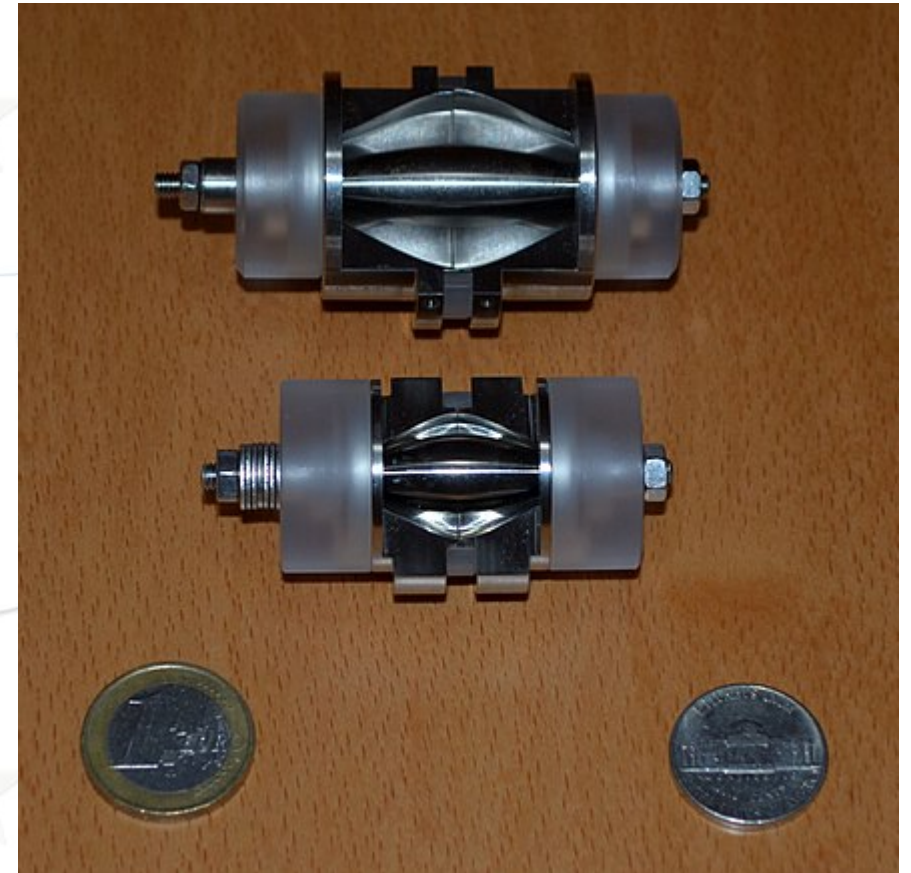
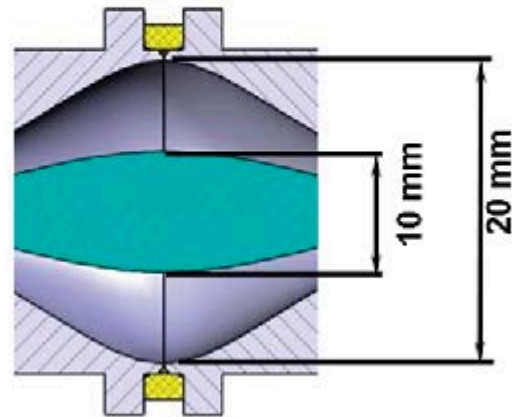

# Comparison of cycle times



Full scan MS @60K + AIF @60K + 10 tMS2 @15K (Exploris 240)

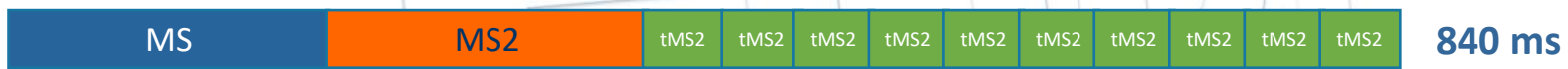

Full scan MS @70K + 10 tMS2 @ 17.5K (QExactive)

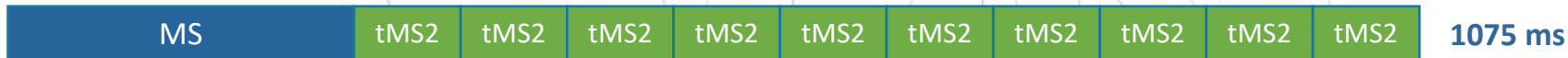

Orbitrap Exploris 240 MS

Vs

Thermo Scientific™ Q Exactive™ Hybrid Quadrupole-Orbitrap™ MS systems  
 (Classic & Plus)

# The Benefit of Using tMS2

## 5 ppb of clothianidin in orange

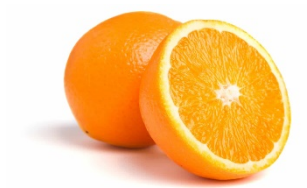

MS2  
m/z 169.05430 ± 5ppm

MS2  
m/z 131.96700 ± 5ppm

MS2  
m/z 113.01680 ± 5ppm

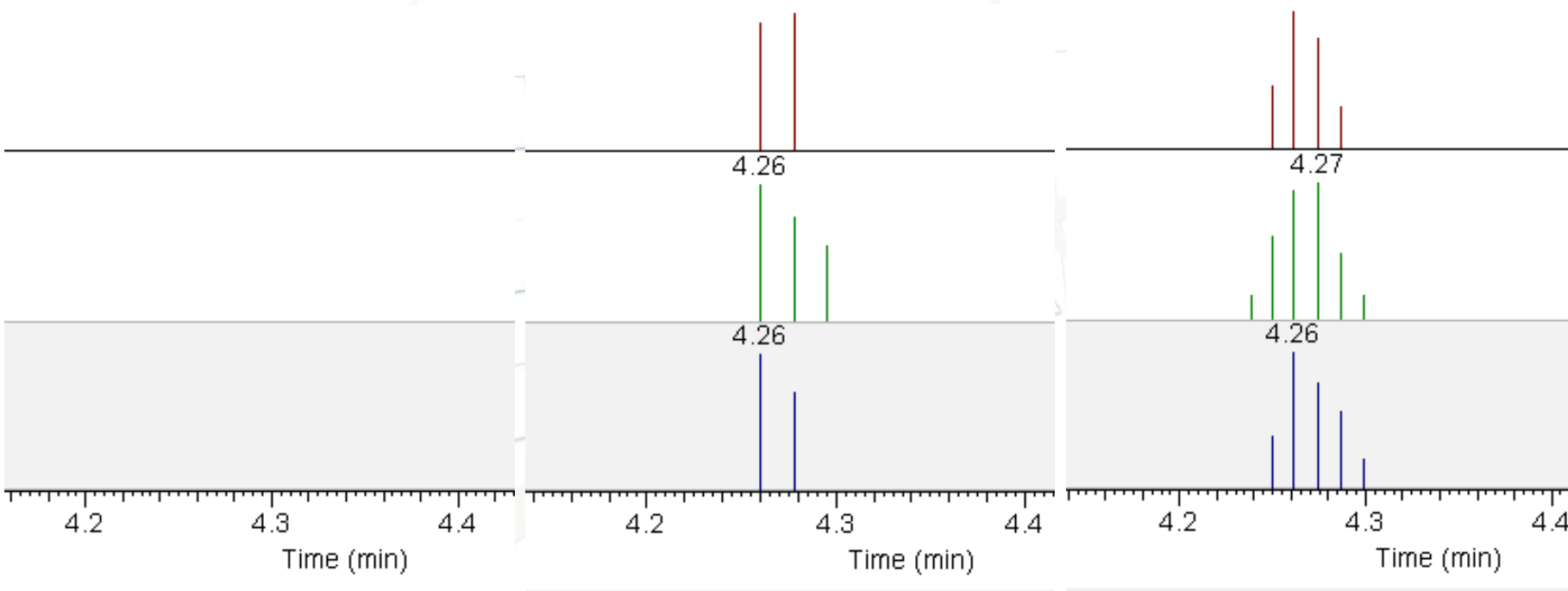

AIF

DIA 20 windows

tMS2

# Current Approach

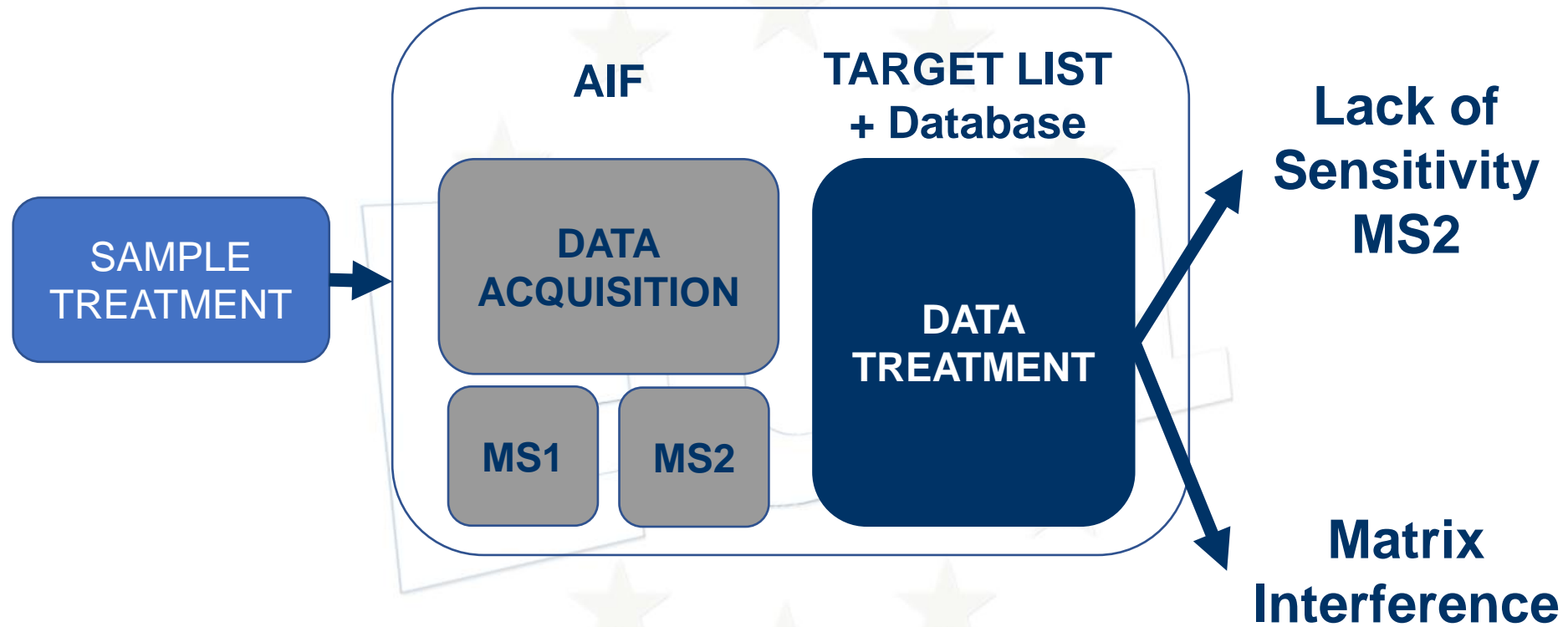

Problem with sensitivity for some compounds

# Screening using a Target List & Database

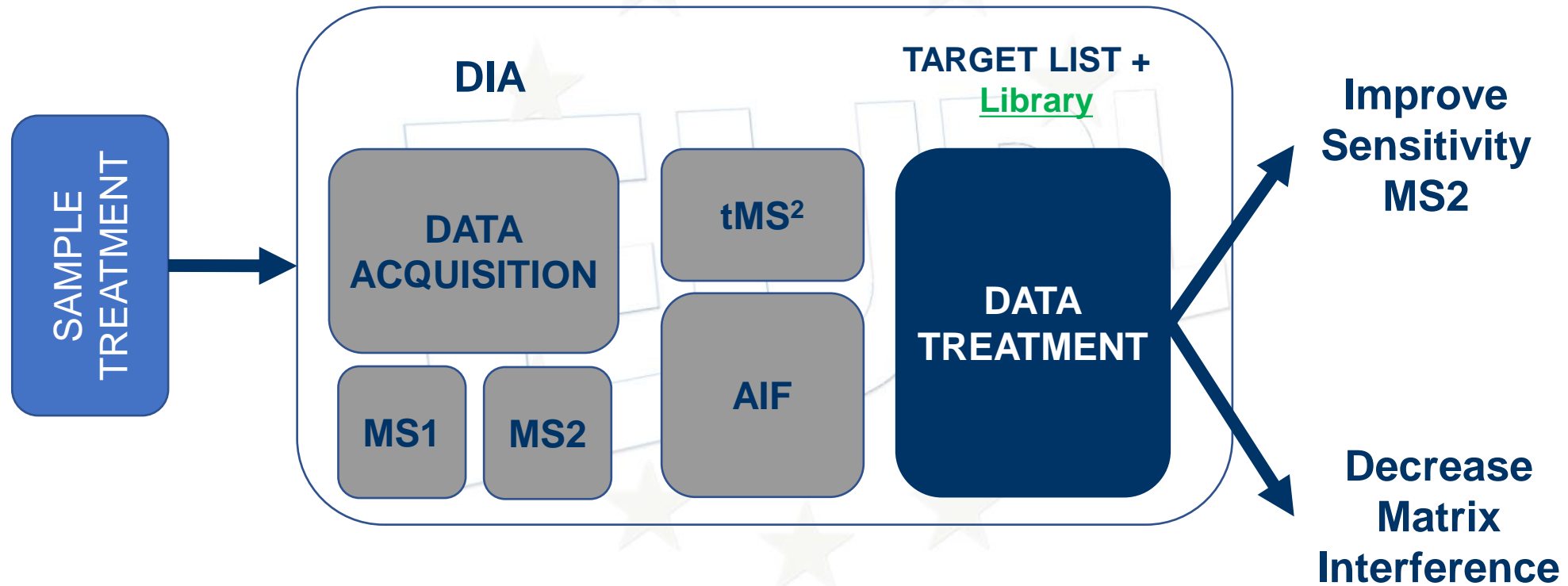



# Linearity

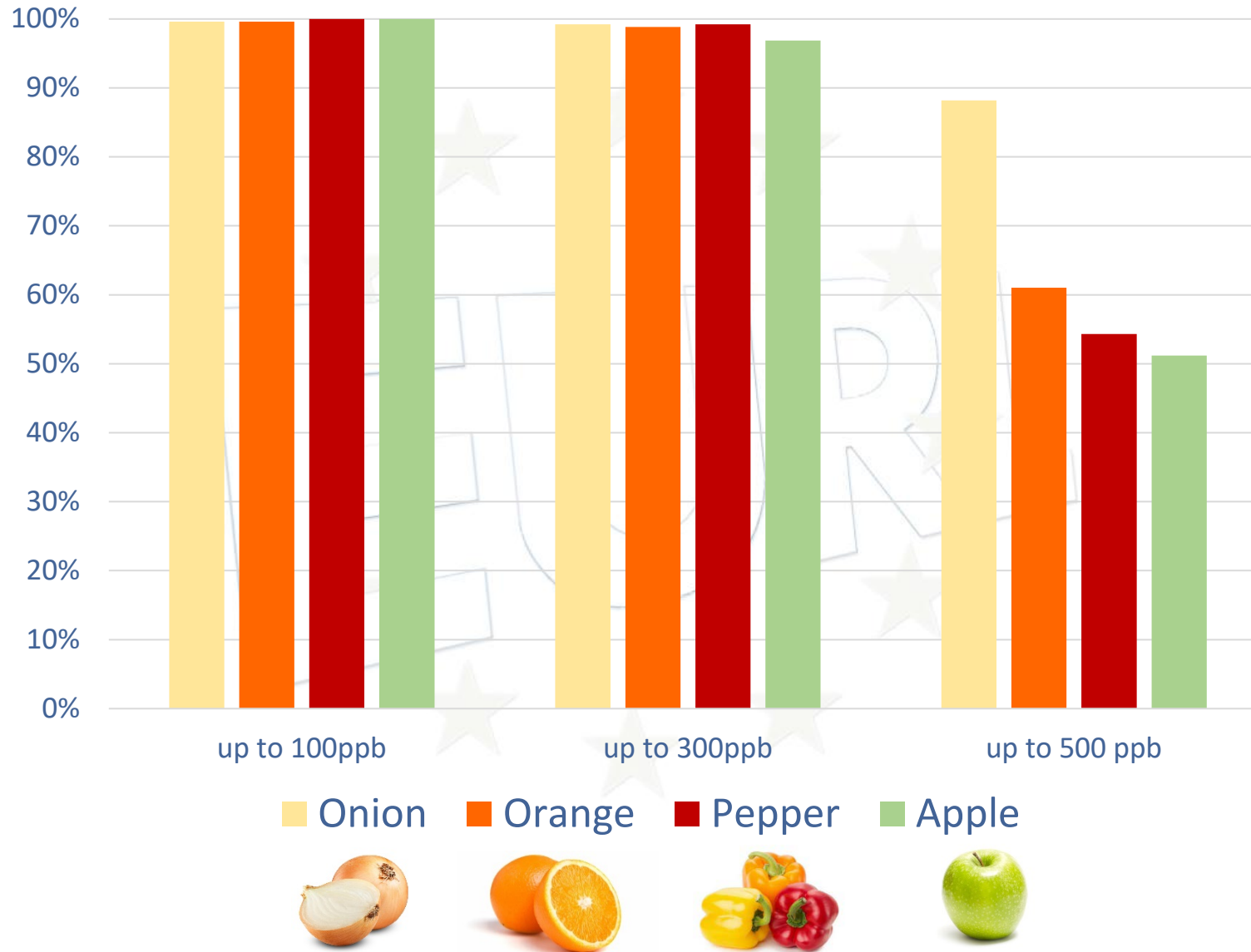

# Increasing the scope

## Identified pesticides/10ppb in Orange

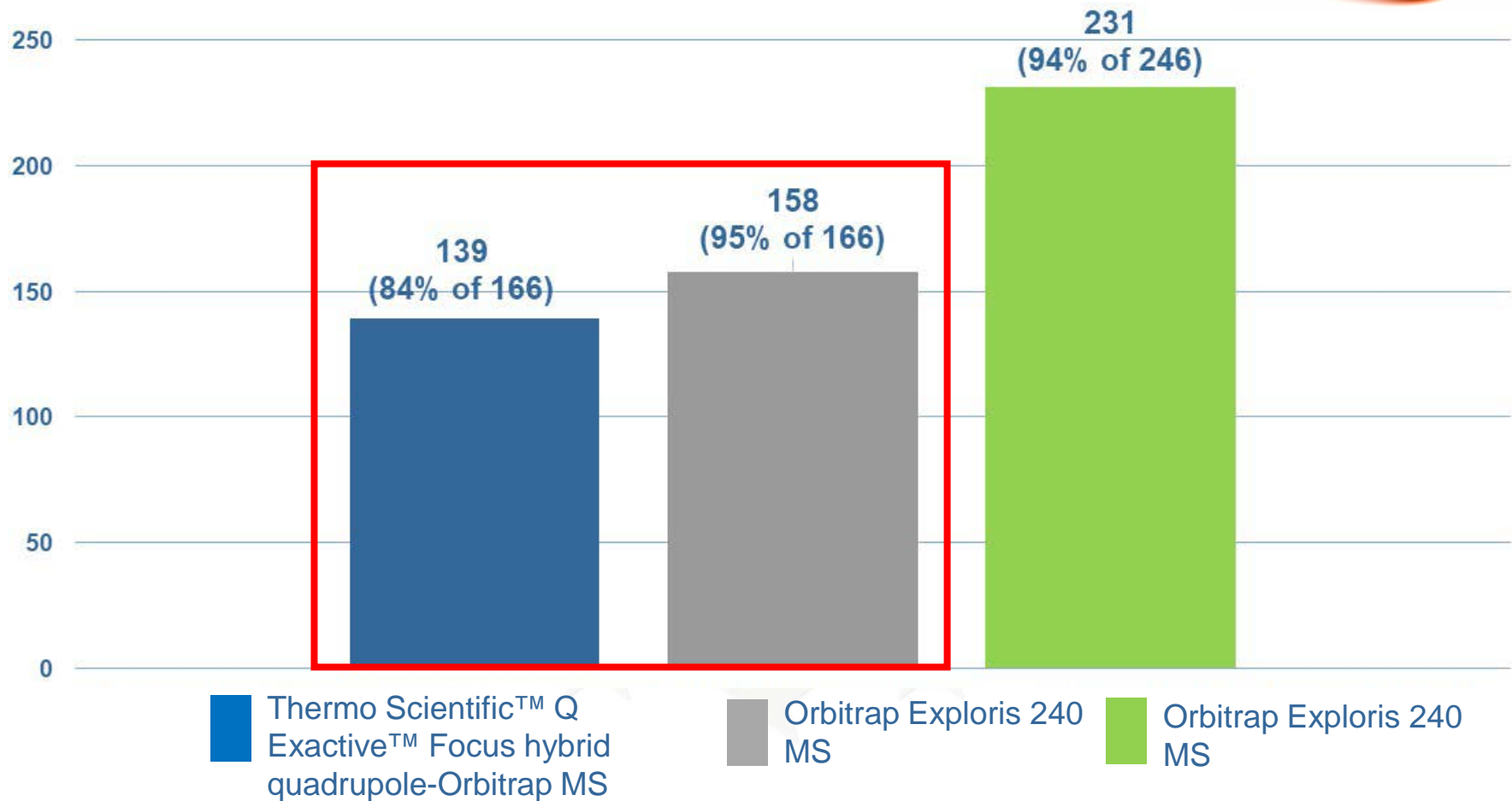
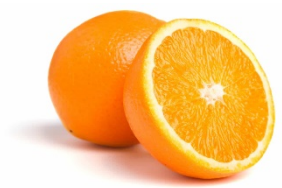

Acquisition modes: QE Focus ( FS/AIF), Orbitrap Exploris 240 MS (FS/AIF/tMS2)

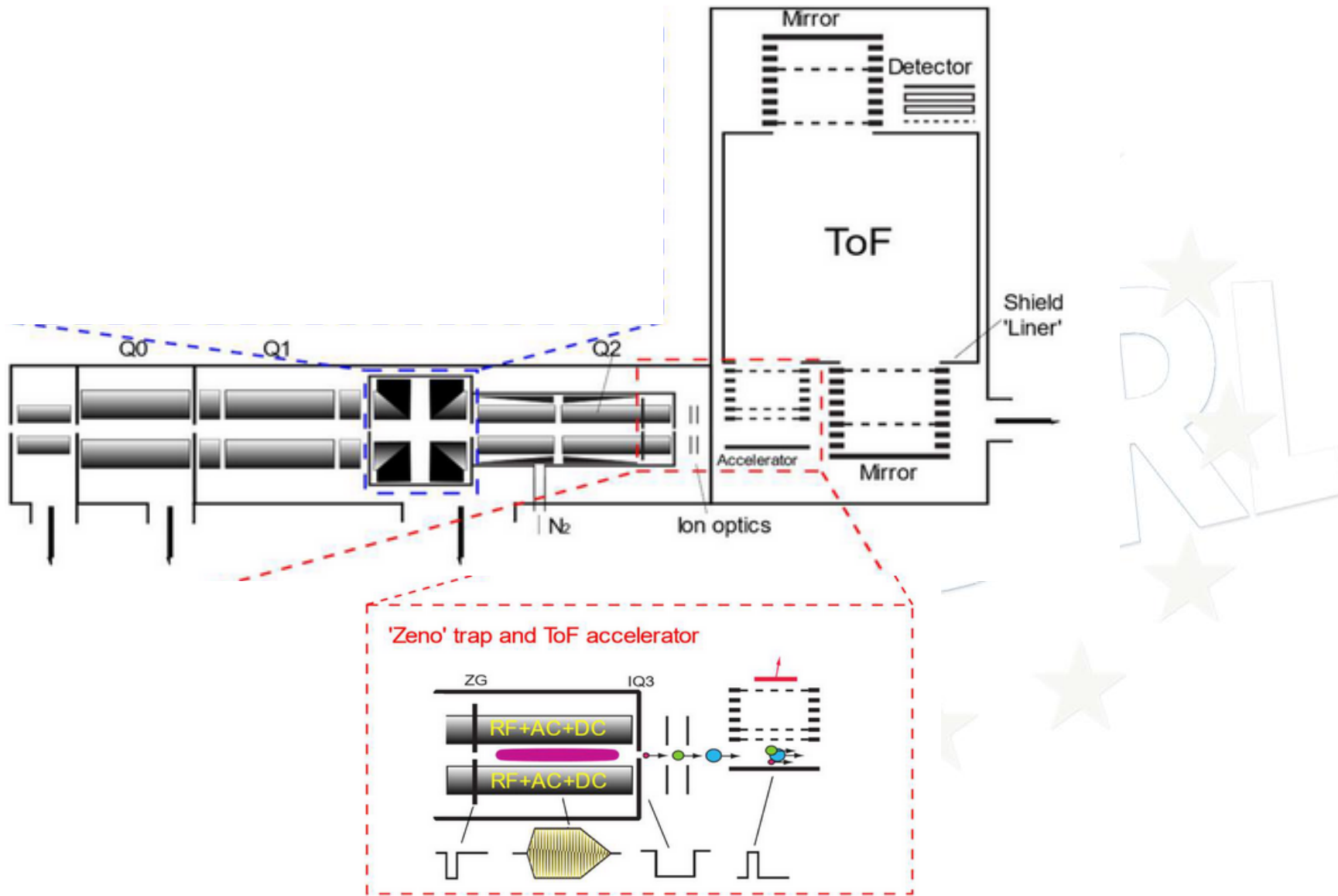

# Zeno trap

- For sensitivity gains in MS/MS
- The Zeno trap provides control of the ion beam from the collision cell into the accelerator
- Ions are gated then released based on potential energy
  - Generally, higher  $m/z$  ions are released first then followed by lower  $m/z$  ions
  - A wide range of ions now arrive in the accelerator to be pushed during the same pulse

Zeno Gate

IQ3

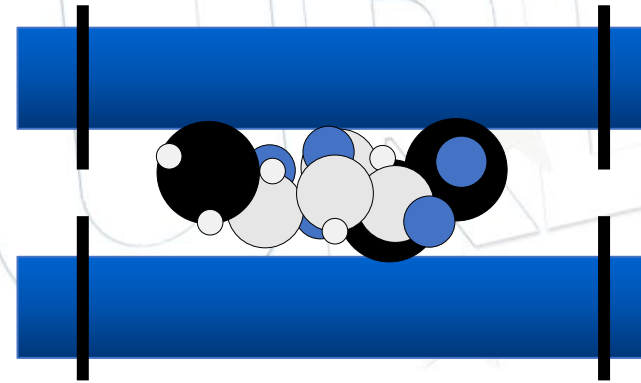

**Quadrupole region**

Continuous ion beam

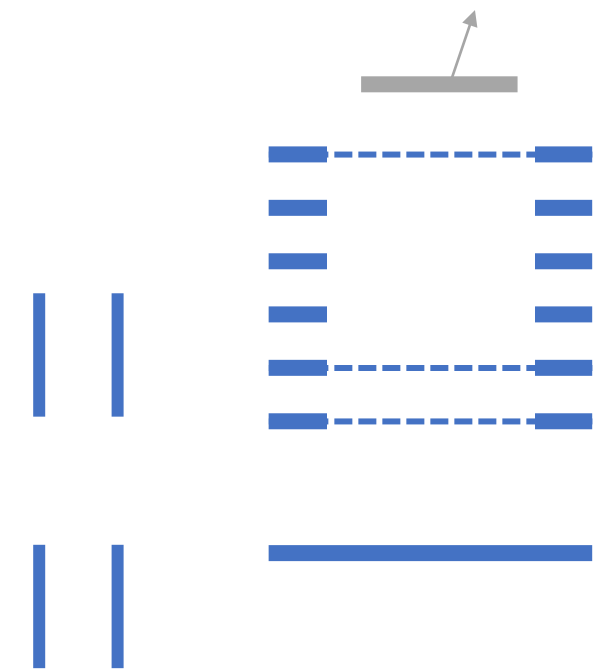

**TOF accelerator**

Ion Pulsing

Lowest detected concentration (cumulative) [282 analytes]  
 (5  $\mu$ L injected, 5-fold dilution, tomato QuEChERS extract)

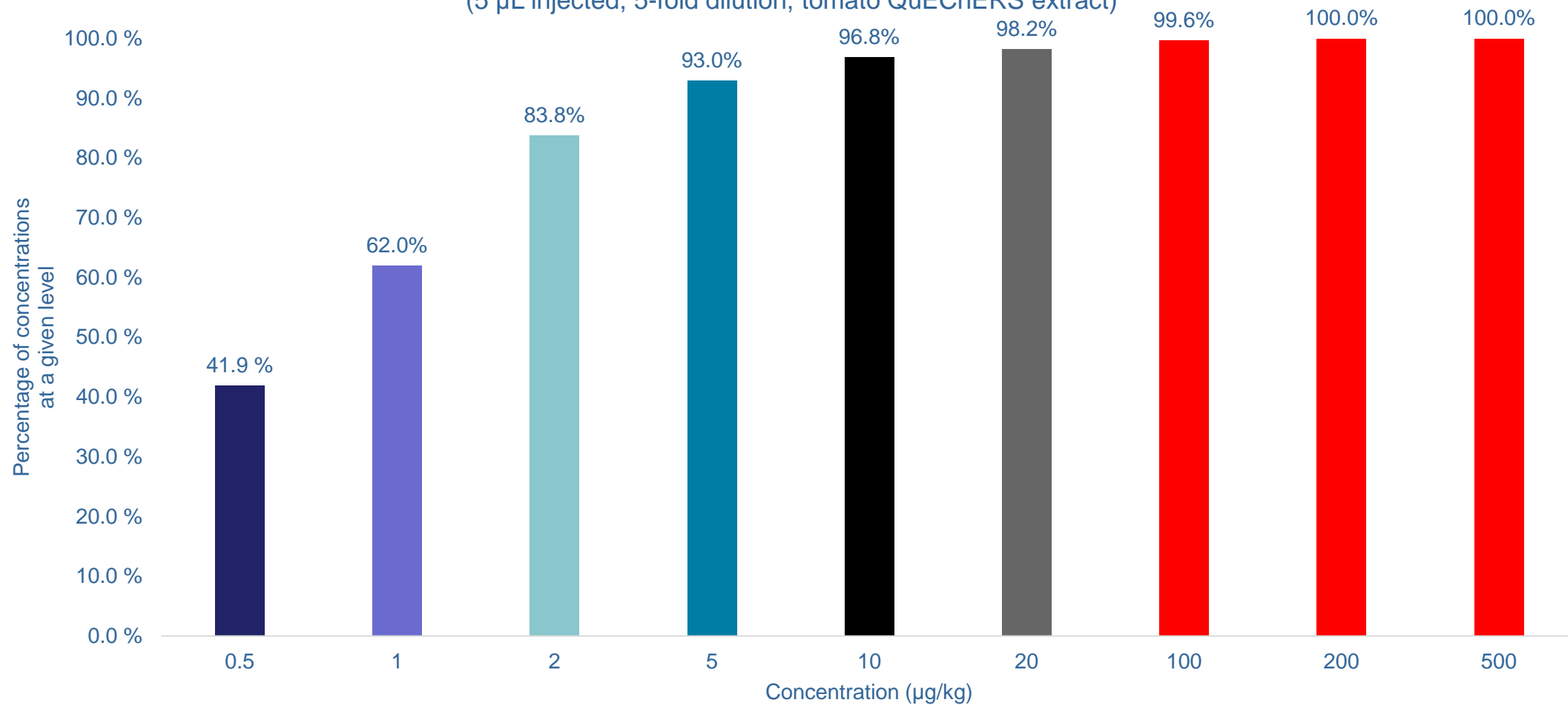

Lowest concentration with  $\geq 2$  detected ions [282 analytes]  
 (5  $\mu$ L injected, 5-fold dilution, tomato QuEChERS extract)

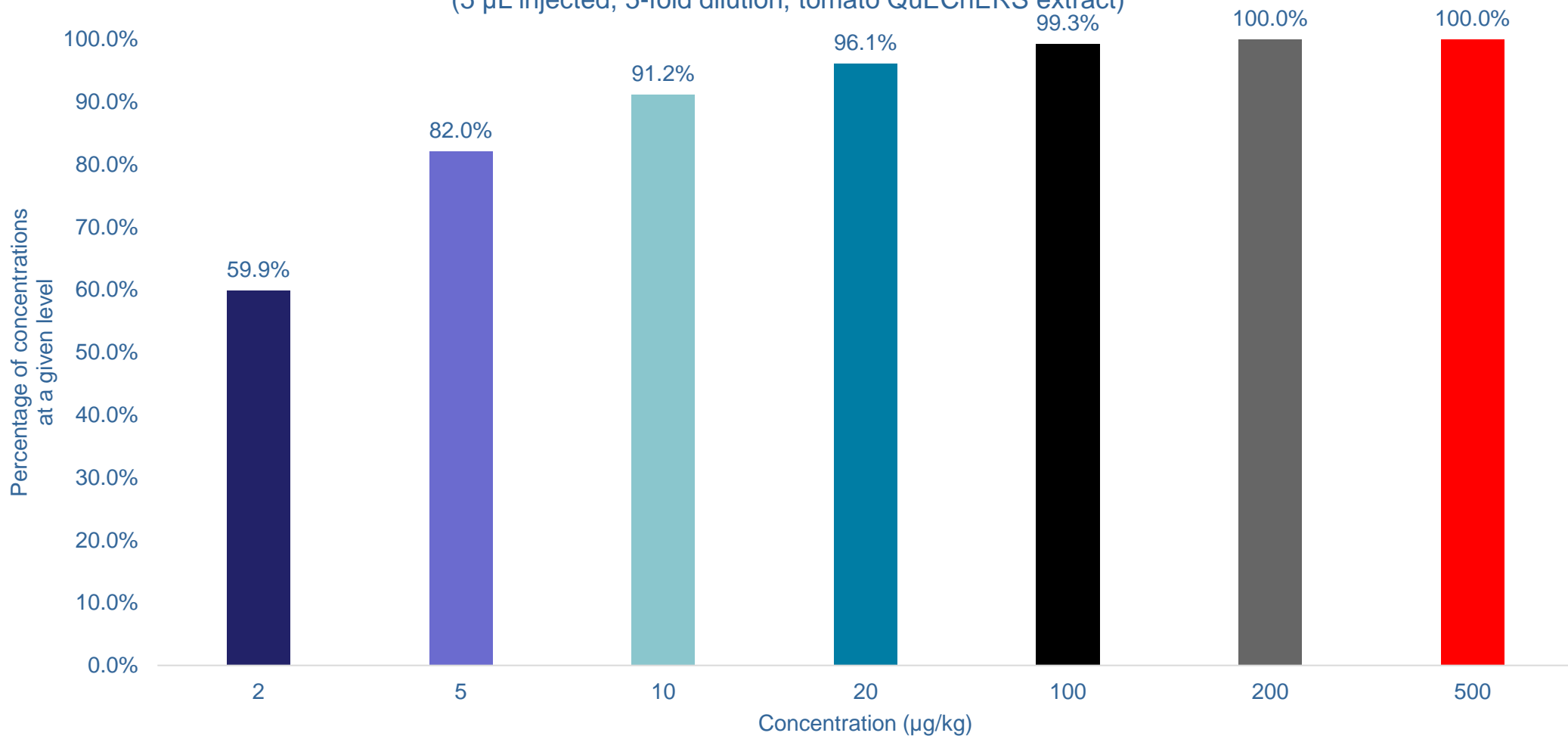

For some compounds, only one ion could be evaluated: 2 at 2 ppb, 1 at 5 ppb, 1 at 10 ppb, 2 at 20 ppb, 2 at 100 ppb, and 1 at 200 ppb

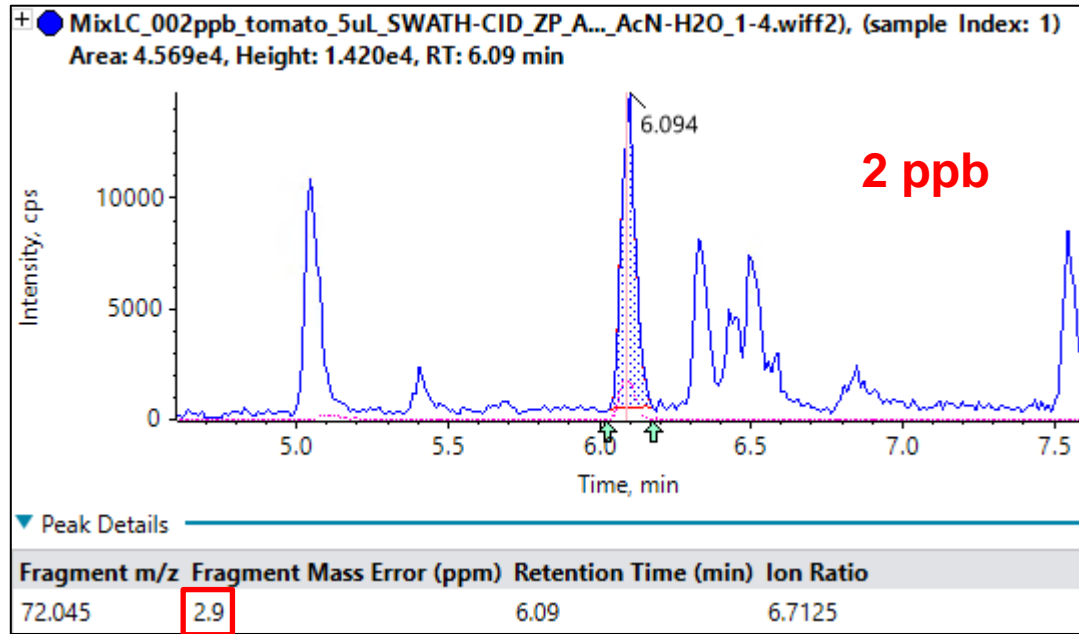

2 µg/L (1:4 dilution with water)

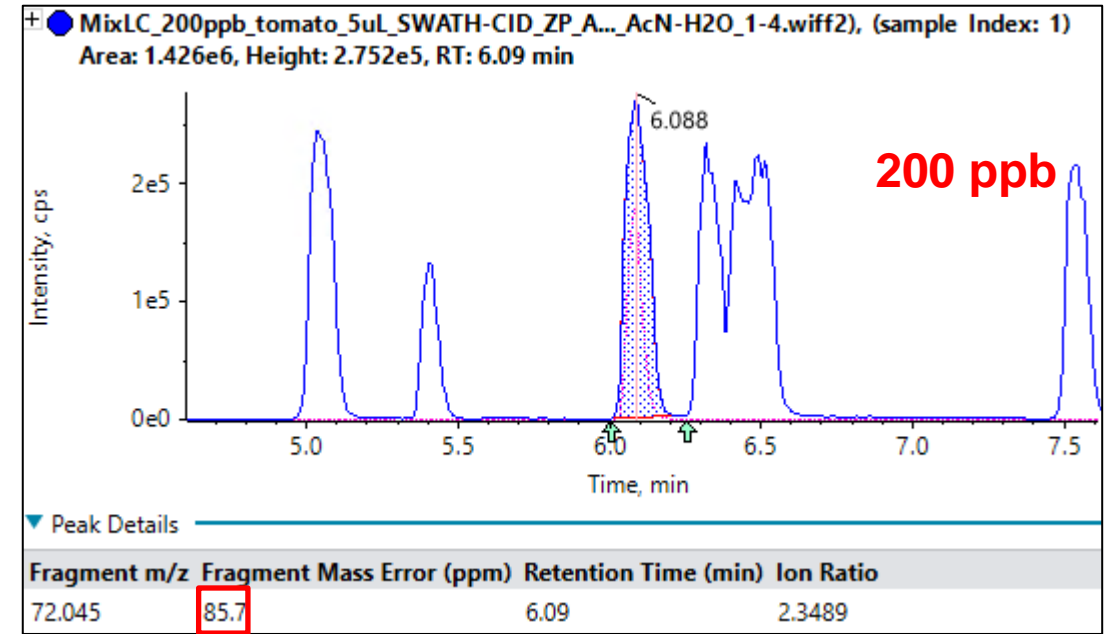
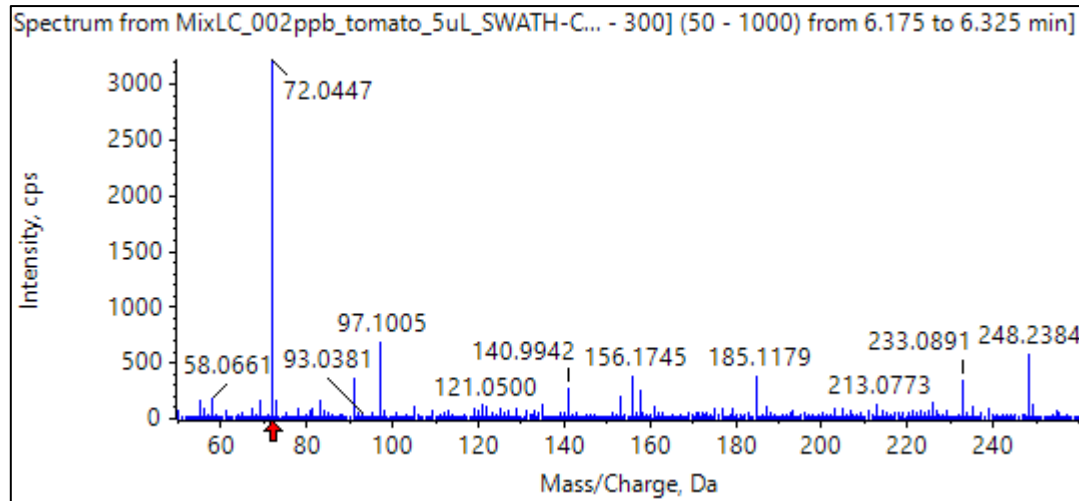

200 µg/L (1:4 dilution with water)

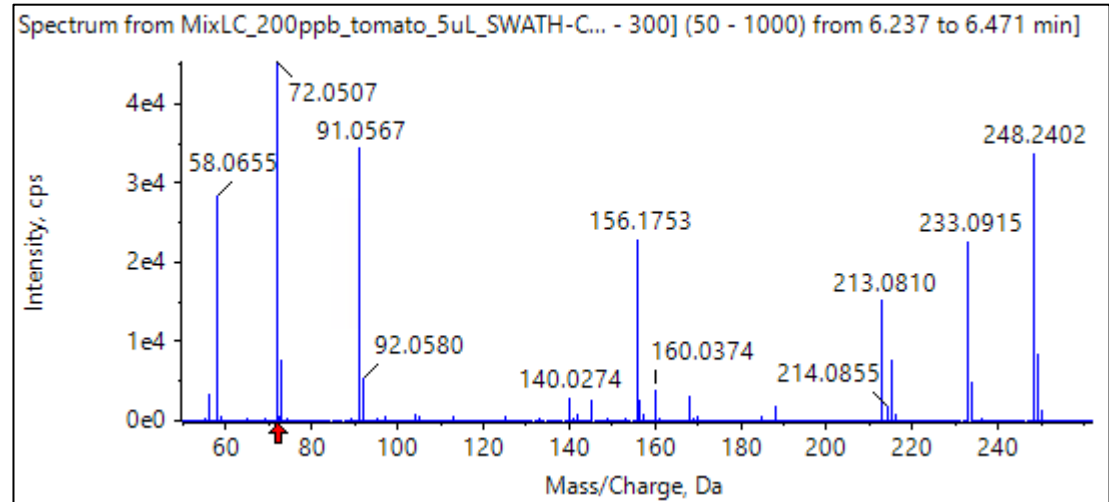

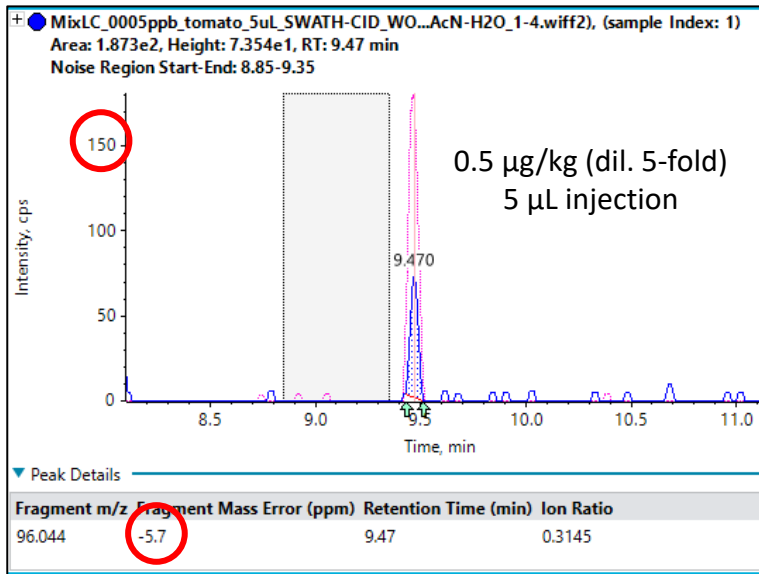

Pyriproxyfen fragment  
 SWATH® (Zeno Pulsing OFF)  
 m/z 96.0444

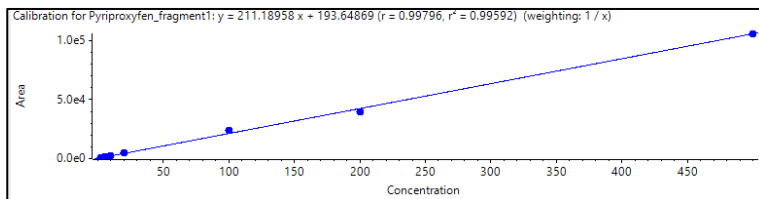

Detect accurately at concentrations as low as  
 0.5 µg/kg and quantitate between 0.5 and  
 20 µg/kg with Zeno Pulsing ON

Quantitate between 0.5 and  
 500 µg/kg with Zeno Pulsing OFF

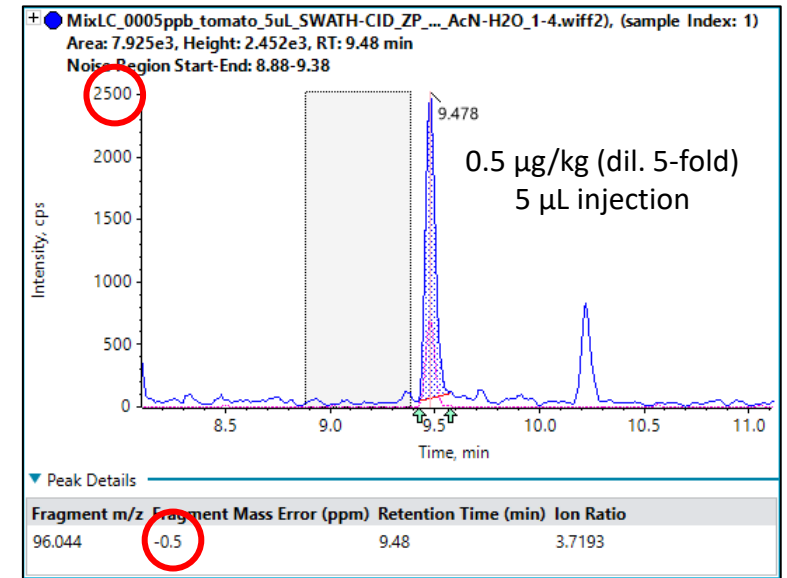

Pyriproxyfen fragment  
 SWATH® (Zeno Pulsing ON)  
 m/z 96.0444

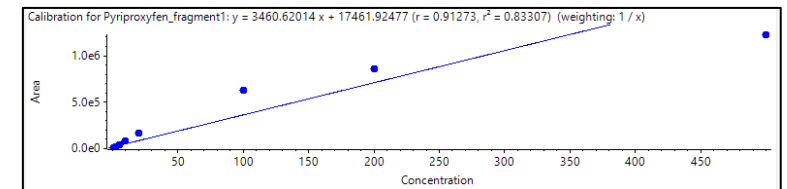



# Increasing the scope

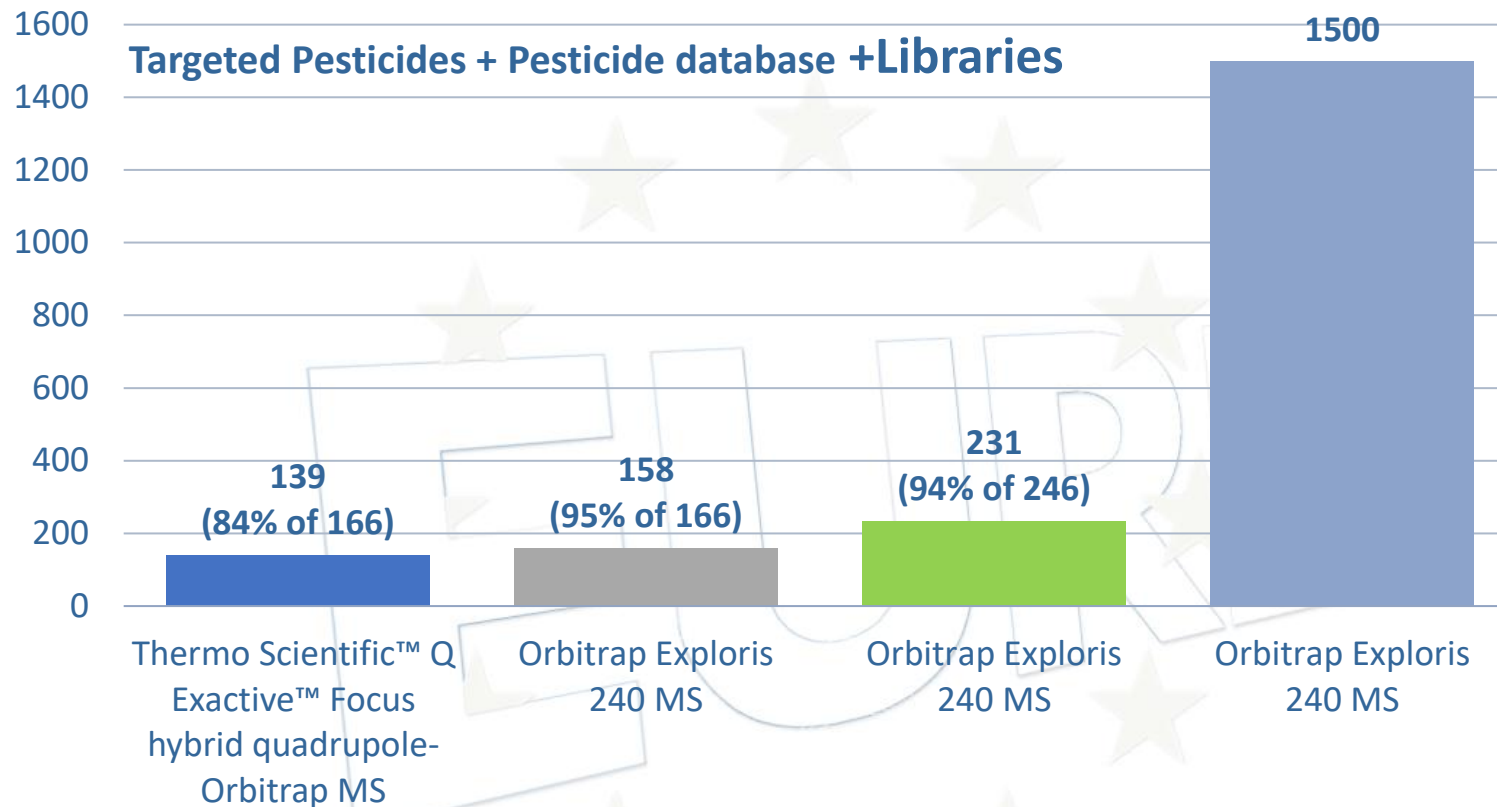

Acquisition modes:

QE Focus ( FS/AIF), Orbitrap Exploris 240 MS (FS/AIF/tMS2),  
 Orbitrap Exploris 240 MS (FS/AIF/tMS2/ Data Dependent)



SAMPLE	MATRIX	TARGET/QUANTITATIVE	SCREENING
001	Kiwi		
002	Kiwi		
003	Kiwi		
004	Kiwi	Phosmet	
005	Kiwi		
006	Kiwi		
007	Kiwi		
008	Kiwi		Forchlorfenuron
009	Kiwi	Boscalid	Forchlorfenuron
010	Onion		Beauvericin; Penicillic-Acid
011	Onion		
012	Onion		
013	Onion		
014	Onion		Beauvericin
015	Onion		Beauvericin_M+NH4; Penicillic-Acid
016	Onion		
017	Onion		
018	Onion		
019	Onion		
020	Onion		
021	Onion		
022	Onion		Beauvericin
023	Onion	Target/Quantitative	
024	Onion		
025	Onion		Beauvericin
026	Orange	Imazalil	
027	Orange	Acetamiprid; Fenpyroximate; Pyrimethanil	Acetamiprid-metabolite-IM-2-1
028	Orange	Pyrimethanil; Thiabendazole; Imazalil	
029	Orange	Acetamiprid; Pyrimethanil; Propiconazole; Imazalil	
030	Orange	Imazalil	
031	Orange	Imidacloprid; Pyriproxyfen	Imidacloprid,desnitro; Imidacloprid,desnitro-olefin
032	Orange	Pyriproxyfen; Imidacloprid	Imidacloprid,desnitro; Imidacloprid,urea
033	Orange	Acetamiprid; Imazalil	
034	Orange	Acetamiprid; Pyriproxyfen	Acetamiprid-metabolite-IM-2-1
035	Orange	Hexythiazox; Pyriproxyfen; Imazalil	
036	Orange	Thiabendazole; Propiconazole; Imazalil	
037	Orange	Acetamiprid; Pyrimethanil; Imazalil	
038	Orange	Acetamiprid	
039	Orange		
040	Orange	Acetamiprid; Fenpyroximate	
041	Orange		
042	Orange	Acetamiprid; Etofenprox; Phosmet; Imazalil	
043	Orange	Acetamiprid; Imazalil	
044	Orange	Thiabendazole; Pyrimethanil; Imazalil	Imidacloprid,desnitro; Thiabendazole,5OH
045	Orange	Pyriproxyfen; Imazalil	
046	Orange		
047	Orange		Imidacloprid,desnitro
048	Pineapple		Beauvericin_M+NH4
049	Raisins	Famoxadone; Fluxapyroxad; Indoxacarb; Mandipropamid; Metalaxyl; Methoxyfenozide; Metrafenone; Penconazole; Proquinazid; Pyrimethanil; Sulfoxaflor; Tebuconazole; Zoxamide	
050	Strawberry	Boscalid; Fluopyram	

C:\Xcalibur\...0611\_screening\Apple\_2

11/06/20 16:22:11

RT: 8.98 - 10.02

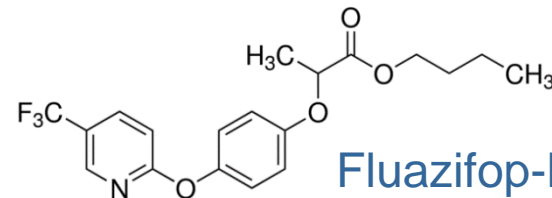
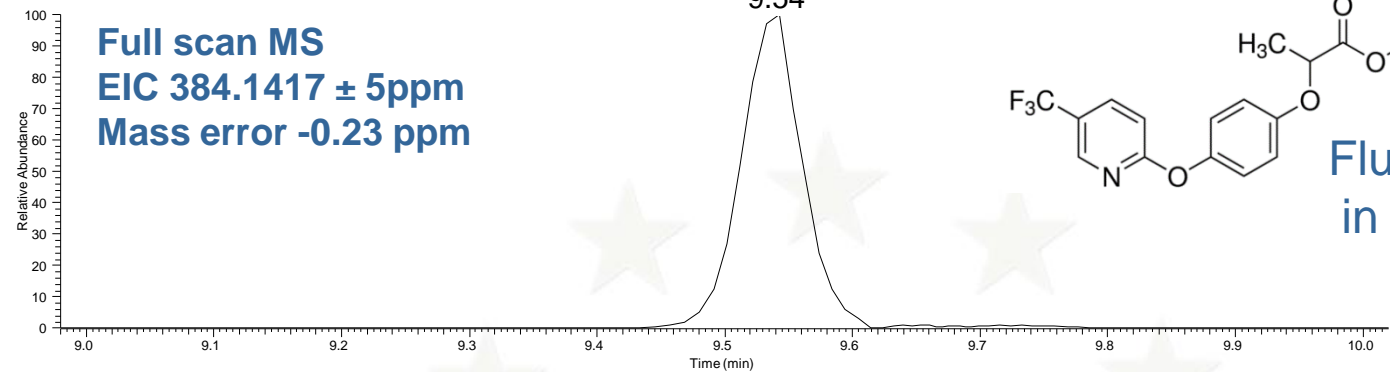

**Fluazifop-Butyl**  
**in apple**



Apple\_2 #8289 RT: 9.52 AV: 1 NL: 2.87E6  
 F: FTMS + p ESI d Full ms2 384.1409@hcd25.00 [50.0000-412.4357]

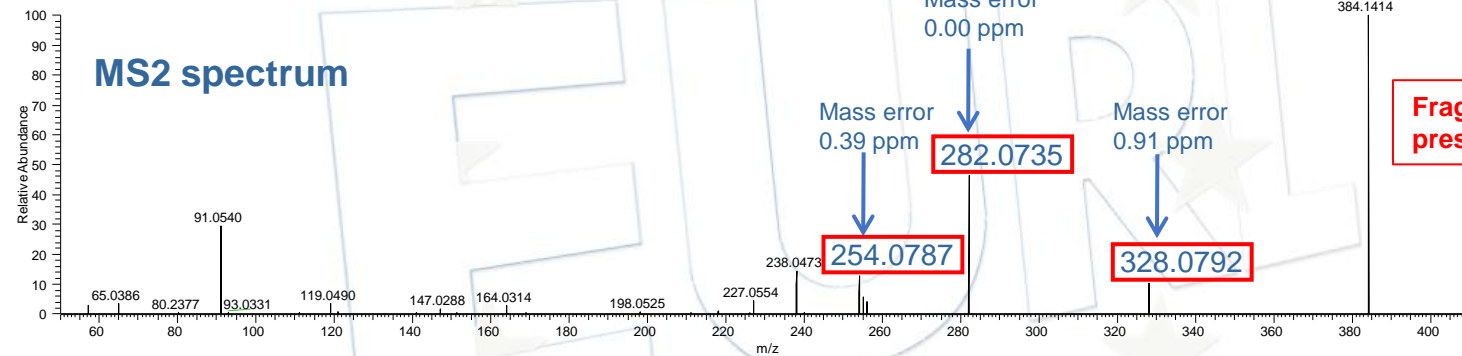

**Fragment ion present in the database**

5803\_Fluazifop-Butyl\_CE40.raw Scan: 1 RT: 0.13 NL: 1.05e08  
 FTMS + p ESI Full ms2 384.14@hcd40.00 [50.00-394.14]

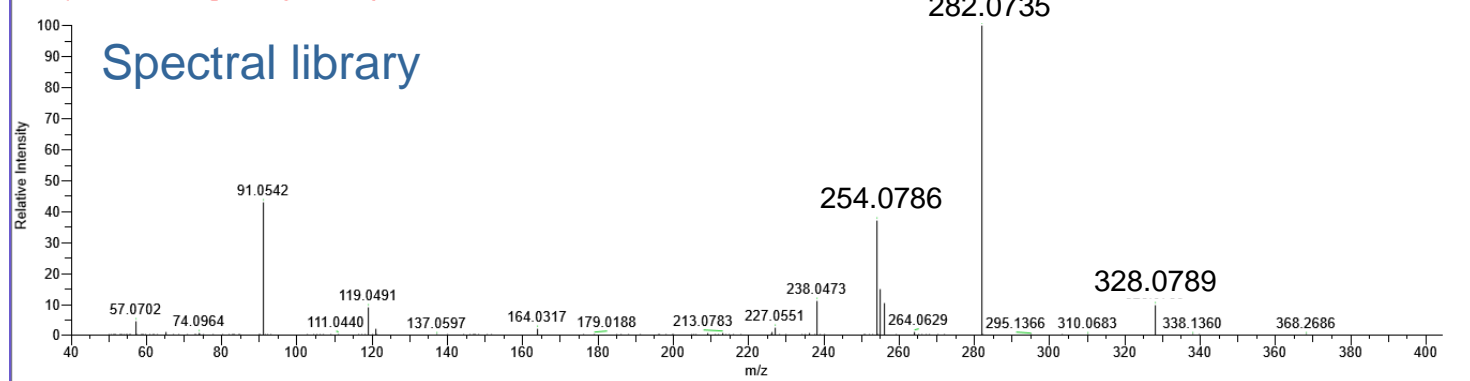

C:\Xcalibur\...0611\_screening\Avocado\_3 11/06/20 21:57:02

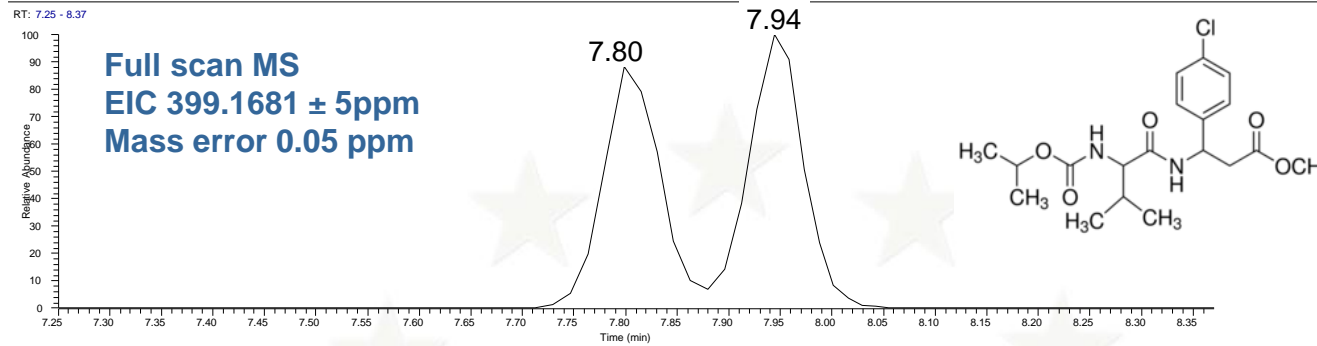

Valifenalate  
in avocado  
(2 peaks)

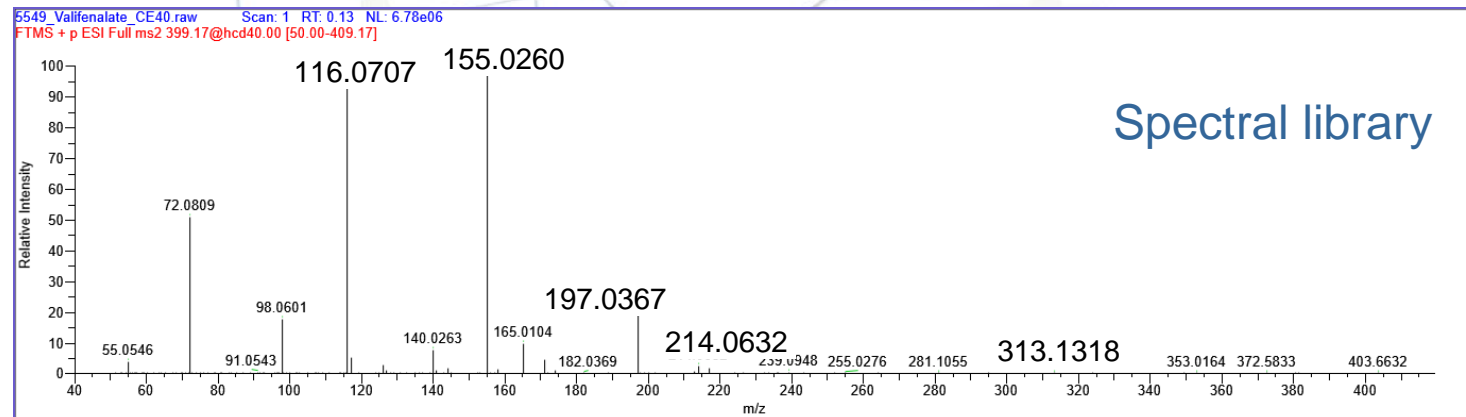
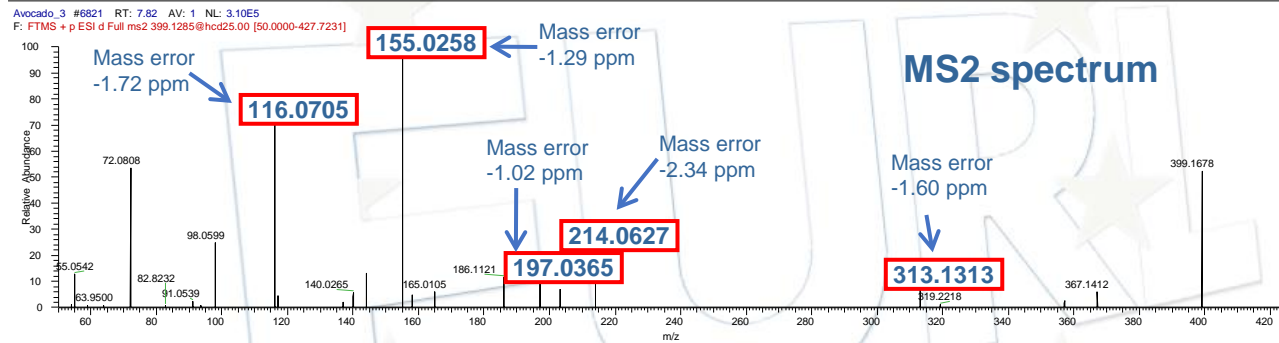



# ION MOBILITY MS

# Variations of Ion Mobility Platforms

Drift Tube (DTIMS)	Traveling Wave (TWIMS)	Trapped IM (TIMS)	Field Asymmetric (FAIMS/DMS/DIMS)	Differential Mobility (DMA)
<ul style="list-style-type: none"> <li>● Direct CCS</li> <li>● Static E Field</li> <li>● No Gas Flow</li> <li>● Pulsed Ion Packet</li> <li>● Comprehensive</li> </ul> <p><b>Commercial Vendors</b></p> <p>Agilent, ToFwerk Excellims</p>	<ul style="list-style-type: none"> <li>● Calibrated CCS</li> <li>● Oscillating E Field</li> <li>● No Gas Flow</li> <li>● Pulsed Ion Packet</li> <li>● Comprehensive</li> </ul> <p><b>Commercial Vendors</b></p> <p>Waters</p>	<ul style="list-style-type: none"> <li>● Calibrated CCS</li> <li>● Static E Field</li> <li>● Parallel Gas Flow</li> <li>● Variable Operation</li> <li>● Both (C &amp; S)</li> </ul> <p><b>Commercial Vendors</b></p> <p>Bruker</p>	<ul style="list-style-type: none"> <li>● No CCS Data</li> <li>● Oscillating E Field</li> <li>● Parallel Gas Flow</li> <li>● Continuous Filter</li> <li>● Scannable</li> </ul> <p><b>Commercial Vendors</b></p> <p>Owlstone, Thermo Sciex, Heartland</p>	<ul style="list-style-type: none"> <li>● Direct CCS</li> <li>● Static E Field</li> <li>● Perpendicular Flow</li> <li>● Continuous Filter</li> <li>● Scannable</li> </ul> <p><b>Commercial Vendors</b></p> <p>SEADM, TSI</p>

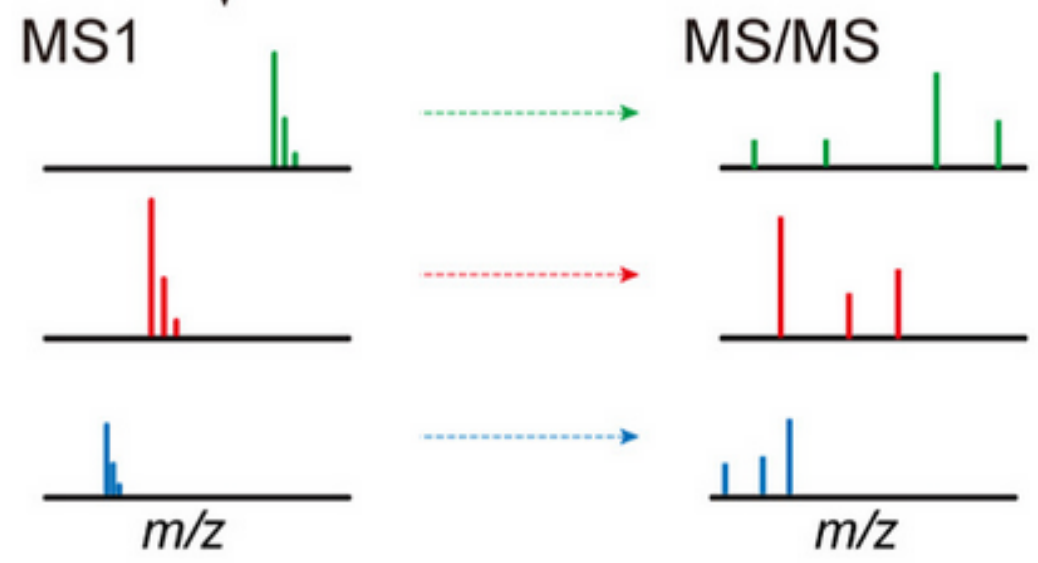
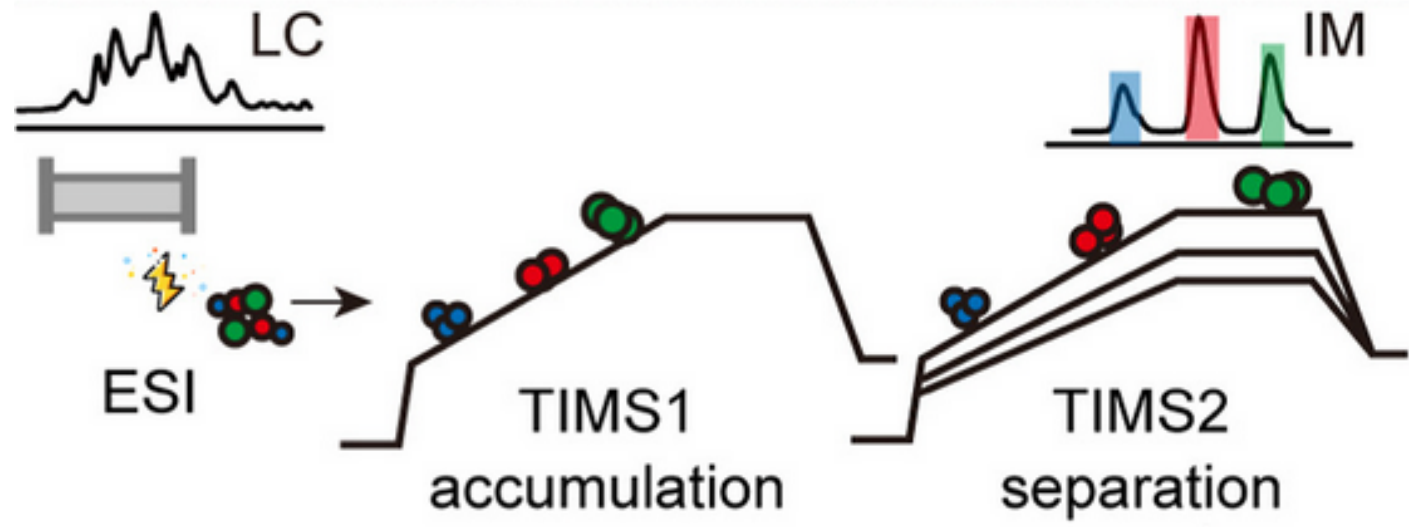
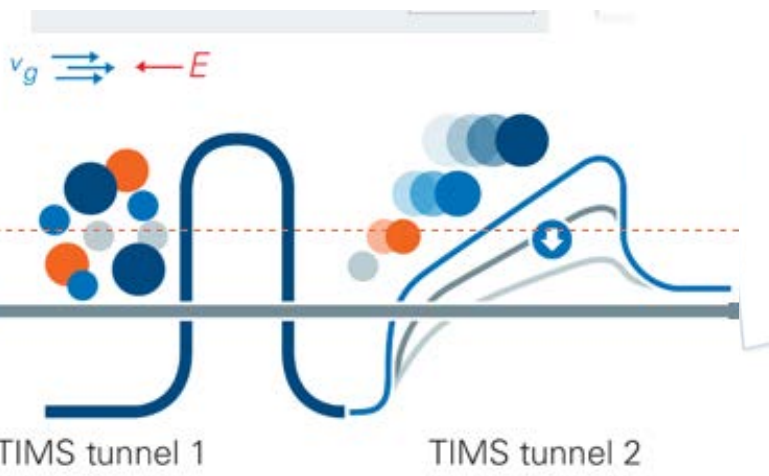
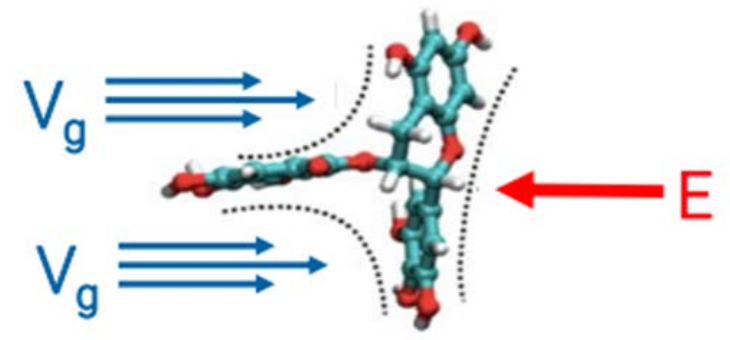

# Método de procesado

Base de datos con los compuestos de interés: parámetros Tr y movilidad

- Exactitud de masa
- Tiempo de retención
- Perfil isotópico de cada ion (fórmula de cada una de las señales)
- Exactitud de masa y perfil isotópico de iones MS2 (DIA)
- Valor CCS (collision cross section) frente al experimental o calculado

General method settings		timsTOF settings		Calibration settings		Workflow settings		Analytes settings		Quantitation settings		Internal Standards		Number formats		Colors Definition	
X	Analyte	Formula	Mass [Da]	RT expected [min]	RT tol. [min] ±	RT narrow [min] ±	RT wide [min] ±	1/K <sub>0</sub> expected [V*s/cm <sup>2</sup> ]	CCS expected [Å <sup>2</sup> ]	Rel. 1/K <sub>0</sub> tol. [%] ±	CCS tol. [%] ±	CCS narrow [%] ±	CCS wide [Å <sup>2</sup> ]				
1	Acephate Fragm 143	C <sub>2</sub> H <sub>3</sub> O <sub>3</sub> PS <sup>1+</sup>	142.9926	3.58	0.50	0.25	0.40	0.5650	123.73	5.0000	5.00	2.00					
2	Acetamidrid	C <sub>10</sub> H <sub>11</sub> ClN <sub>4</sub>	222.0672	4.87	0.50	0.25	0.40	0.7261	154.26	5.0000	5.00	2.00					
3	Acrinathrin (NH4)	C <sub>28</sub> H <sub>21</sub> F <sub>8</sub> NO <sub>5</sub>	541.1324	13.17	0.50	0.25	0.40	1.0500	215.46	7.0000	7.00	2.00					
4	Alachlor Fragm 238	C <sub>13</sub> H <sub>17</sub> ClNO <sup>1+</sup>	238.0993	9.81	0.50	0.25	0.40	0.7079	149.86	5.0000	5.00	2.00					
5	Albendazole	C <sub>12</sub> H <sub>15</sub> N <sub>3</sub> O <sub>2</sub> S	265.0885	8.74	0.50	0.25	0.40	0.7847	165.20	5.0000	5.00	2.00					
6	Aldicarb Fragm 116	C <sub>5</sub> H <sub>10</sub> NS <sup>1+</sup>	116.0528	5.75	0.50	0.25	0.40	0.5371	119.83	5.0000	5.00	2.00					
7	Ametoctradin	C <sub>15</sub> H <sub>25</sub> N <sub>5</sub>	275.2110	11.19	0.50	0.25	0.40	0.8439	177.35	5.0000	5.00	2.00					
8	Amisulbrom Mob1	C <sub>13</sub> H <sub>13</sub> BrFN <sub>2</sub> O <sub>4</sub> S <sub>2</sub>	464.9576	11.58	0.50	0.25	0.40	0.8929	184.08	5.0000	5.00	2.00					
9	Amisulbrom Mob2	C <sub>13</sub> H <sub>13</sub> BrFN <sub>2</sub> O <sub>4</sub> S <sub>2</sub>	464.9576	11.58	0.50	0.25	0.40	0.9427	194.34	5.0000	5.00	2.00					
10	Anilofos	C <sub>13</sub> H <sub>15</sub> ClNO <sub>3</sub> PS <sub>2</sub>	367.0233	10.37	0.50	0.25	0.40	0.8633	179.33	5.0000	5.00	2.00					
11	Atrazine	C <sub>8</sub> H <sub>14</sub> ClN <sub>3</sub>	215.0938	7.65	0.50	0.25	0.40	0.7026	149.54	5.0000	5.00	2.00					
12	AvermectinB1a (Abamectin) (NH4)	C <sub>48</sub> H <sub>78</sub> NO <sub>14</sub> <sup>1+</sup>	890.5260	13.48	0.50	0.25	0.40	1.3800	280.66	5.0000	5.00	2.00					
13	Azinphos-ethyl Fragm 160	C <sub>8</sub> H <sub>8</sub> N <sub>2</sub> O <sup>1+</sup>	160.0505	9.72	0.50	0.25	0.40	0.8552	188.55	5.0000	5.00	2.00					
14	Azinphos-methyl (Guthion) Fragm 1...	C <sub>8</sub> H <sub>8</sub> N <sub>2</sub> O <sup>1+</sup>	160.0505	8.29	0.50	0.25	0.40	0.7770	168.66	5.0000	5.00	2.00					
15	Azinphos-methyl (Guthion) Fragm 1...	C <sub>8</sub> H <sub>8</sub> N <sub>2</sub> O <sup>1+</sup>	160.0505	8.29	0.50	0.25	0.40	0.8158	177.08	5.0000	5.00	2.00					
16	Azoxystrobin	C <sub>22</sub> H <sub>17</sub> N <sub>3</sub> O <sub>5</sub>	403.1168	8.45	0.50	0.25	0.40	0.9452	195.73	5.0000	5.00	2.00					
17	BAC 10	C <sub>11</sub> H <sub>11</sub> N <sup>1+</sup>	176.0856	0.00	0.50	0.25	0.40	0.9440	177.30	10.0000	10.00	0.00					

Ions		Ion Ratios		Rules												
	Ion	Ion formula	m/z	Spectrum type	Mandatory	Quant. ion	Reference ion	Ion ratio	Ion ratio tol. [...]	EIC width[mDa] ±	EIC width[ppm] ±	mDa narrow ±	ppm narrow ±	mDa wide ±	ppm wide ±	1/K <sub>0</sub> expected [V*s/cm <sup>2</sup> ]
1	153.070	C <sub>12</sub> H <sub>9</sub> <sup>1+</sup>	153.0699	bbCID	<input checked="" type="checkbox"/>	<input type="checkbox"/>				2.0000	13.0659	1.0	6.53	1.50	9.80	0.7151
2	170.096	C <sub>12</sub> H <sub>12</sub> N <sup>1+</sup>	170.0964	bbCID	<input checked="" type="checkbox"/>	<input type="checkbox"/>				2.0000	11.7580	1.0	5.88	1.50	8.82	0.8484
3	184.076	C <sub>12</sub> H <sub>10</sub> NO <sup>1+</sup>	184.0757	bbCID	<input type="checkbox"/>	<input type="checkbox"/>				2.0000	10.8651	1.0	5.43	1.50	8.15	0.7151
4	I	C <sub>13</sub> H <sub>12</sub> NO <sup>1+</sup>	198.0913	FullScan	<input checked="" type="checkbox"/>	<input checked="" type="checkbox"/>				2.0000	10.0964	1.0	5.05	1.50	7.57	0.7151
5	198.091	C <sub>13</sub> H <sub>12</sub> NO <sup>1+</sup>	198.0913	bbCID	<input type="checkbox"/>	<input type="checkbox"/>				2.0000	10.0964	1.0	5.05	1.50	7.57	0.7151
6	Fragm 198 of (M+H)	C <sub>13</sub> H <sub>12</sub> NO <sup>1+</sup>	198.0913	FullScan	<input type="checkbox"/>	<input type="checkbox"/>				2.0000	10.0964	1.0	5.05	1.50	7.57	0.8484
7	198.091 of (M+H)	C <sub>13</sub> H <sub>12</sub> NO <sup>1+</sup>	198.0913	bbCID	<input type="checkbox"/>	<input type="checkbox"/>				2.0000	10.0964	1.0	5.05	1.50	7.57	0.8484
8	I+1	C <sub>13</sub> H <sub>12</sub> NO <sup>1+</sup>	199.0946	FullScan	<input type="checkbox"/>	<input type="checkbox"/>	I	0.146	50.000	2.0000	10.0455	1.0	5.02	1.50	7.53	0.7151
9	Bifenazate (M+H)	C <sub>17</sub> H <sub>21</sub> N <sub>2</sub> O <sub>3</sub> <sup>1+</sup>	301.1547	FullScan	<input checked="" type="checkbox"/>	<input type="checkbox"/>				2.0000	6.6411	0.9	3.00	2.11	7.00	0.8484



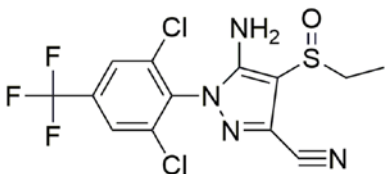

# Cromatograma y movilograma

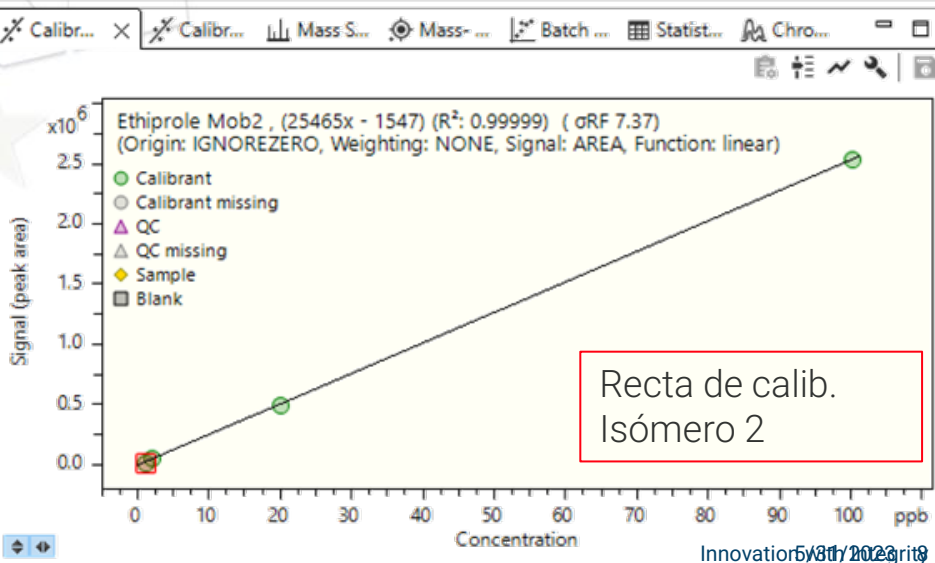
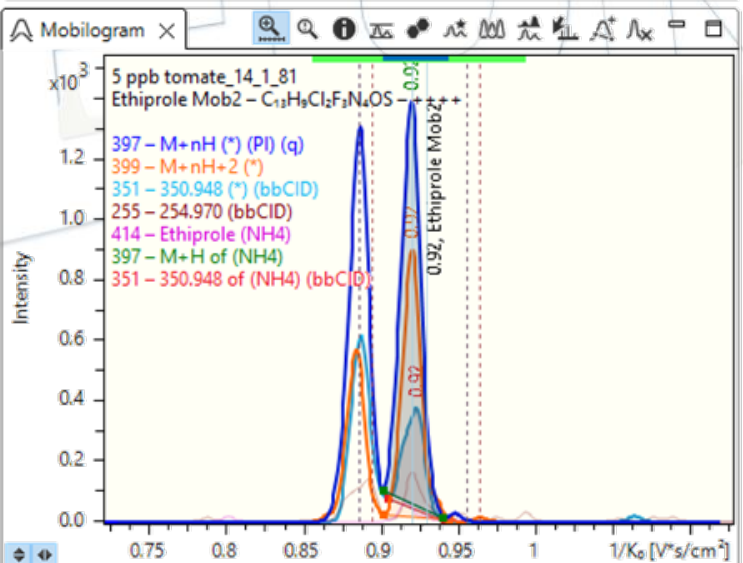
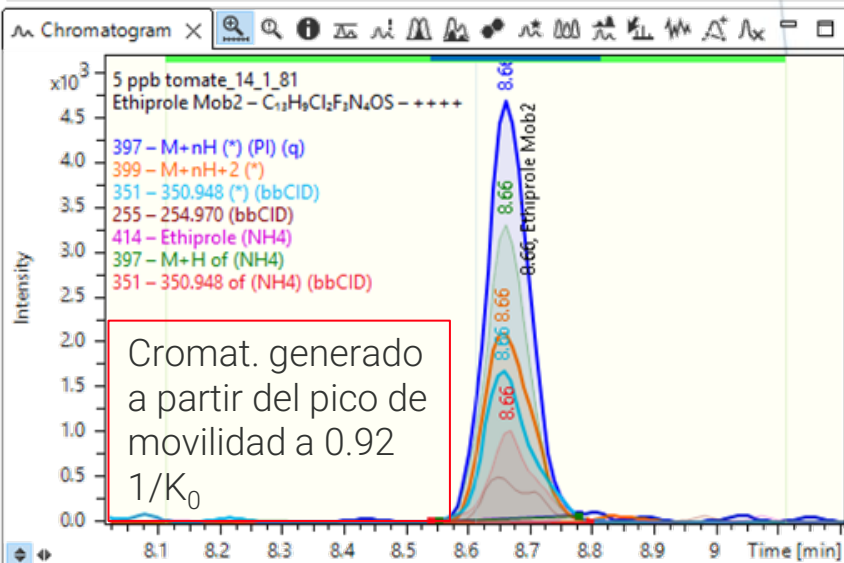
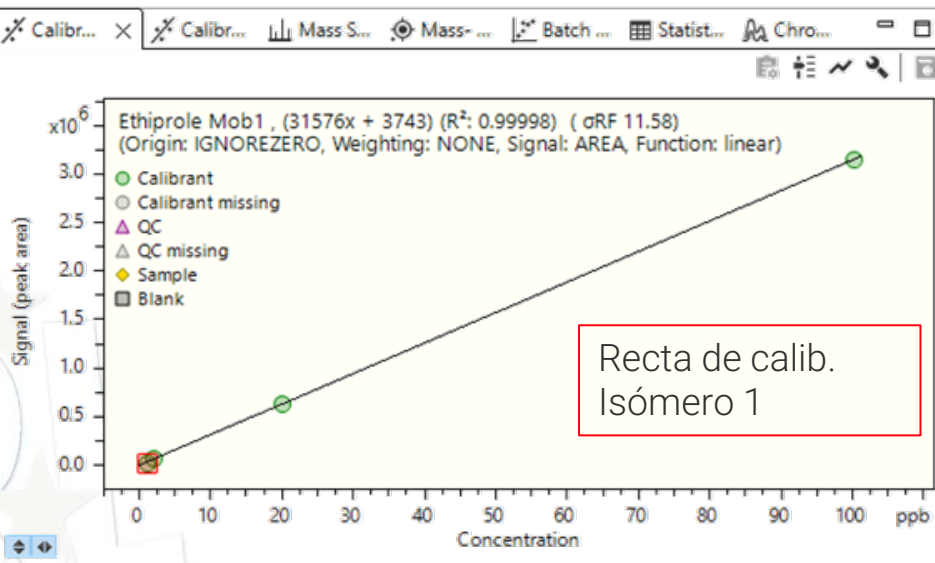
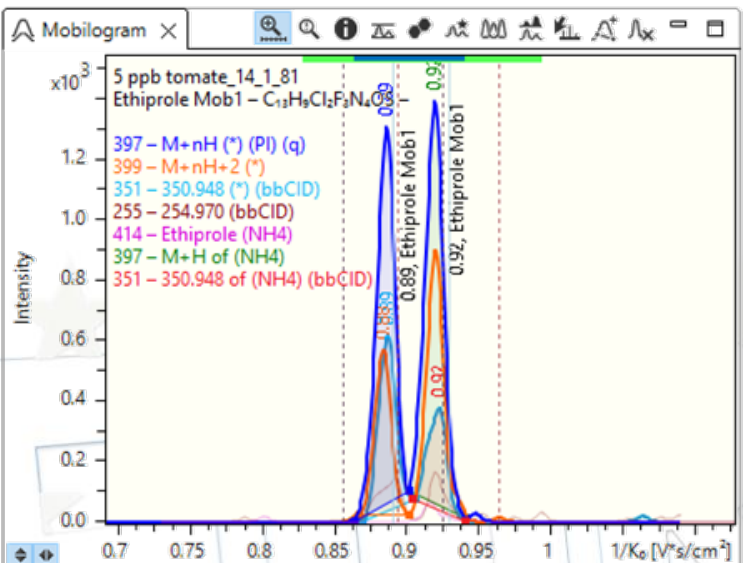
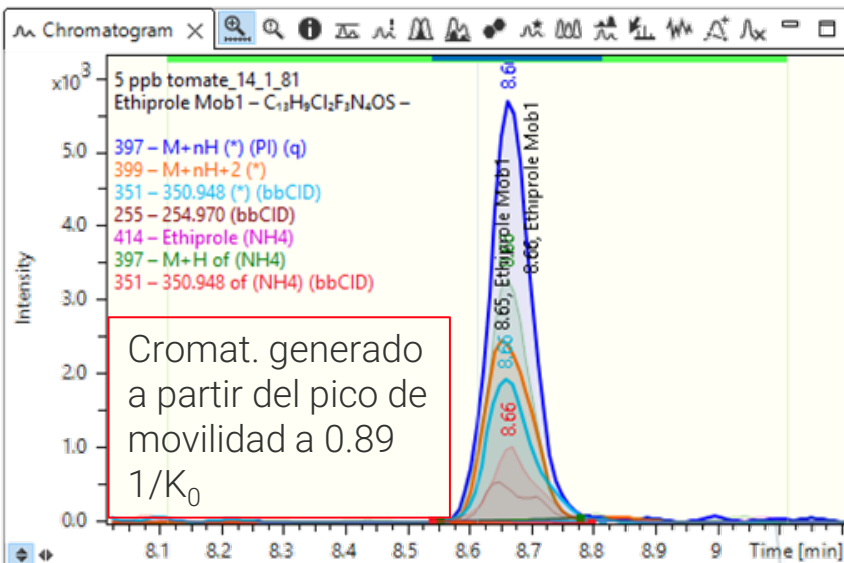

# TIMS desactivado

1 ppb Mefentrifluconazole

TIMS activado

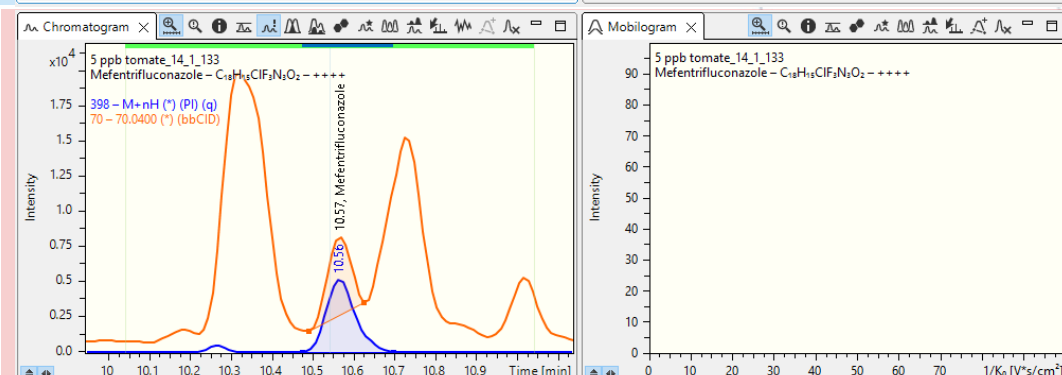
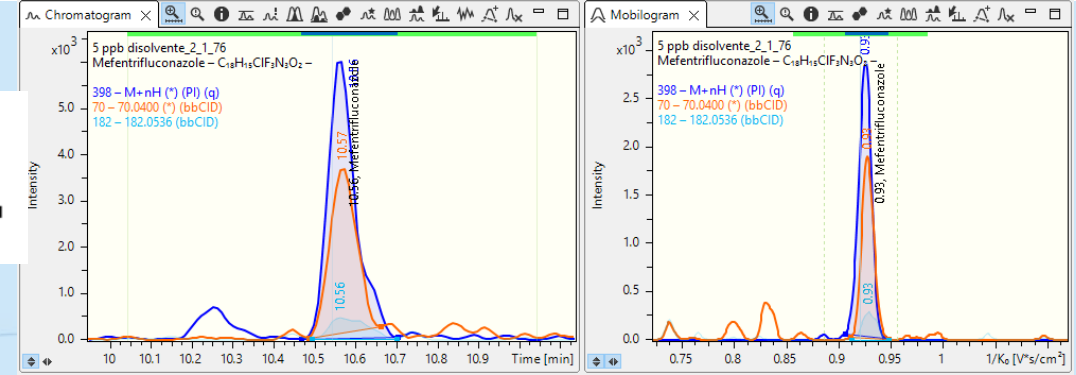
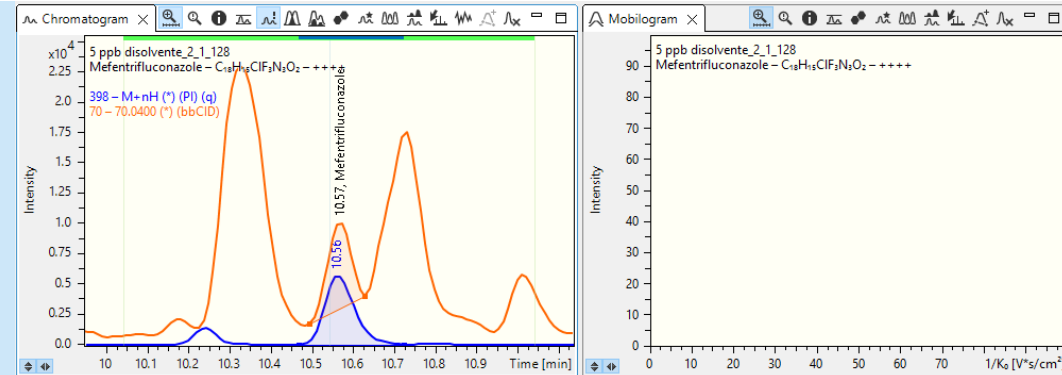
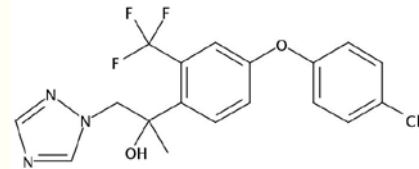

Tomate

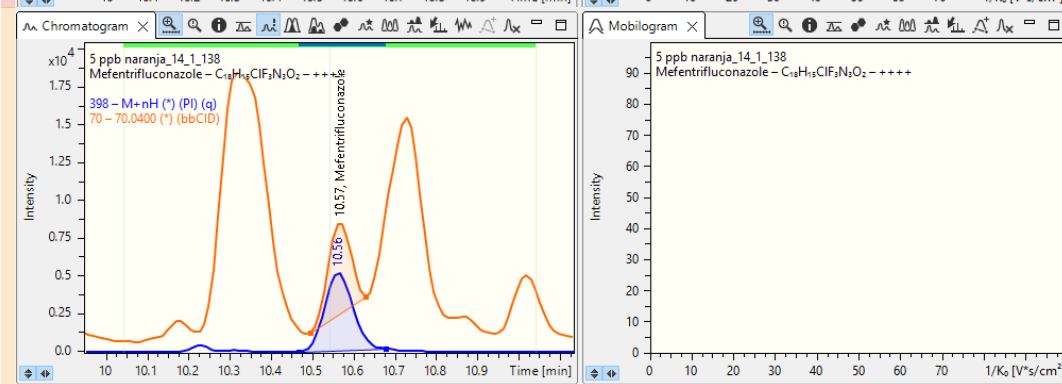
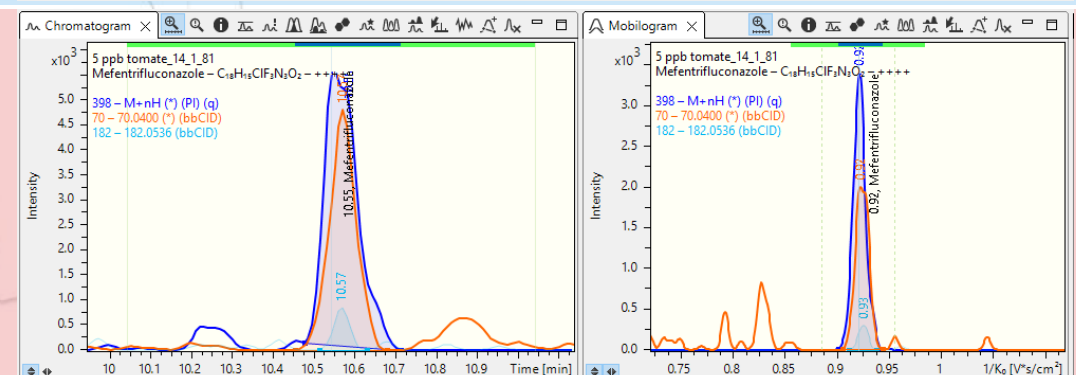

Naranja

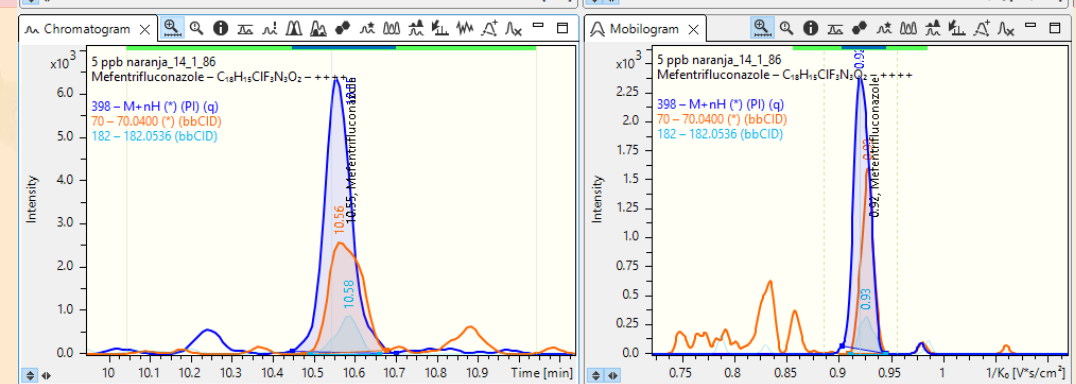



HEMP  
FOR HUMANITY

# EUROPEAN GREEN DEAL

## #EUGREENDEAL

Transforming the EU's economy for a sustainable future.





## The Farm to Fork and Biodiversity Strategies set two key targets for pesticides

- **Target 1:** to reduce by 50% the use and risk of **chemical pesticides** by 2030
- **Target 2:** to reduce by 50% the use of more **hazardous pesticides** by 2030

### Target 1 - 50% reduction in use and risk of chemical pesticides

This target will be measured based on:

- the **quantities of active substances** contained in the pesticides which are placed on the market (sold), and therefore used, in each Member State, and
- the **hazard properties of these active substances**

### Target 2 - 50% reduction in the use of more hazardous pesticides

This will be measured using data on the **quantities of more hazardous active substances**, the so called '**candidates for substitution**', contained in the pesticides which are placed on the market (sold) and therefore used in each Member State

# YEAR 1: PESTICIDE MONITORING



APIStrips were employed for a preliminary monitoring in **three European countries** throughout two months

A total of **120 APIStrips** were employed: 40 APIStrips per country, with 5 apiaries and 4 sampling rounds in each of them

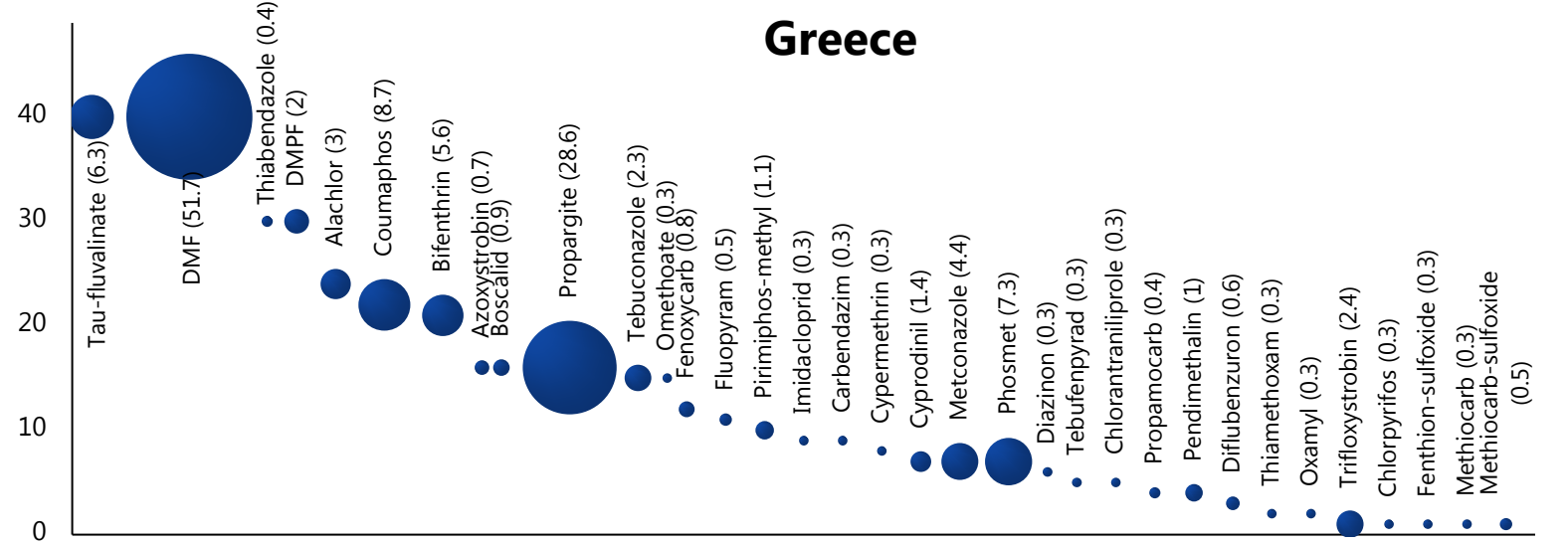
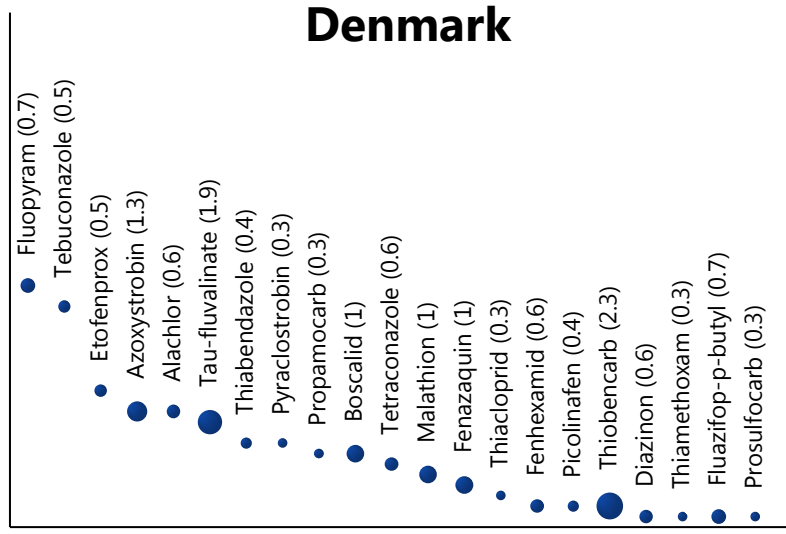
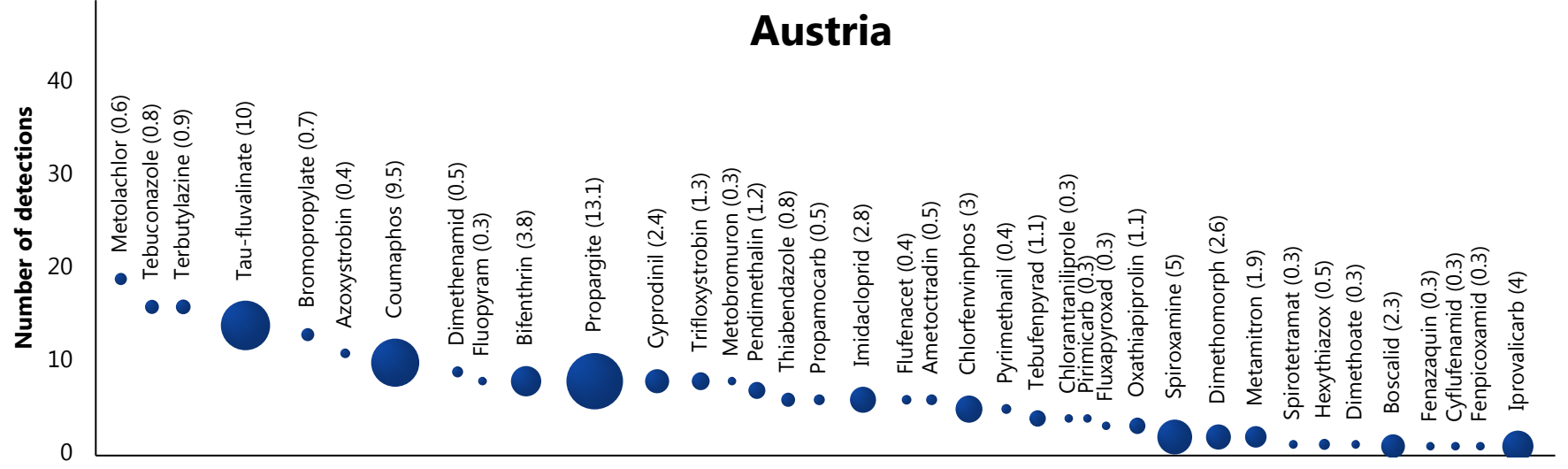

# Identification of LC-QQQ-MS/MS vs ZenoTOF (Zeno Trap Pulsing) SWATH acquisition mode. HR-MRM Confirmation

APISTrips

LC Column Kinetex® 1.7µm C8 100 Å

**100** x 2.1 mm

Pesticides	GR001-3_R1		GR002-4_R2		AT004-2_R1		AT001-2_R1 (µg/kg)		AT005-2_R2	
	SWATH	HR-MRM	SWATH	HR-MRM	SWATH	HR-MRM	SWATH	HR-MRM	SWATH	HR-MRM
Ametoctradin					1.7					
Azoxystrobin	2.4		1.8						1.9	
Boscalid	1.4		<b>3.8</b> <i>(Only one ion)</i>	<b>CONFIRMED</b>	<b>2.3</b> <i>(Only one ion)</i>	<b>CONFIRMED</b>				
Coumaphos	6		2.3							
Cyprodinil	<b>1.6</b> <i>(Only one ion)</i>	<b>CONFIRMED</b>					<b>2.3</b> <i>(Only one ion)</i>	<b>CONFIRMED</b>		
Dimethomorph					4.9					
Fenoxycarb	1.1		4							
Fluopyram			0.7							
Iprovalicarb					4					
Metobromuron					0.5					
Oxathiapipronil									2.8	
Phosmet			13							
Pirimiphos-methyl			<b>0.6</b>							
Propamocarb									<b>1</b> <i>(Only one ion)</i>	<b>CONFIRMED</b>
Spiroxamine					8.8					
Tebuconazole	<b>1.3</b> <i>(Only one ion)</i>	<b>CONFIRMED</b>	11.2		<b>1.5</b> <i>(Only one ion)</i>	<b>CONFIRMED</b>			<b>0.95</b> <i>(Only one ion)</i>	<b>CONFIRMED</b>
Terbutylazine					<b>0.6</b>				0.8	
Thiabendazole	0.7				1		1.7			
Trifloxystrobin			2.4		0.6		1.2			

# ZenoTOF: Cyprodinil confirmation using HR-MRM acquisition mode

APIStrip sample

Cyprodinil precursor  $m/z$  226.1339

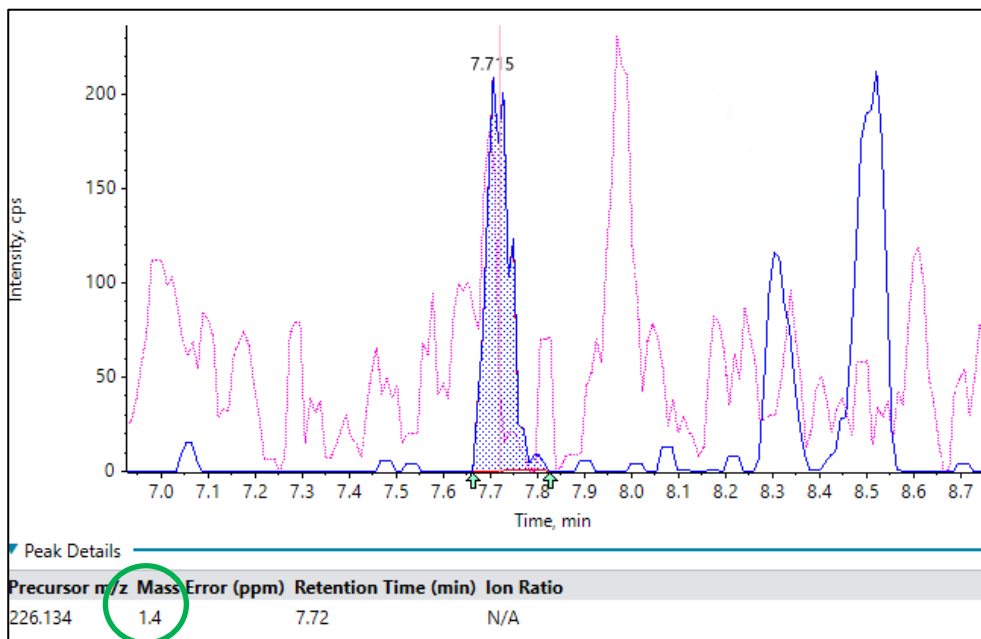

Cyprodinil fragment  $m/z$  108.0808

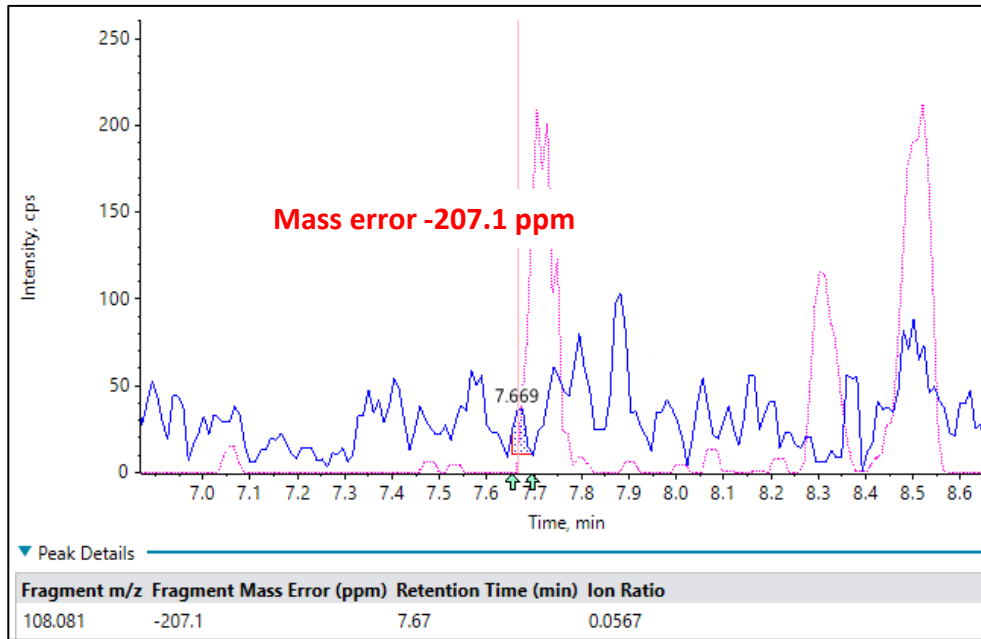

SWATH

Zeno Pulsing

Acc. Time TOF MS: 80 ms

Acc. Time TOF MSMS: 50 ms

HR-MRM

Zeno Pulsing

Acc. Time TOF MS: 250 ms

Acc. Time TOF MSMS: 250 ms

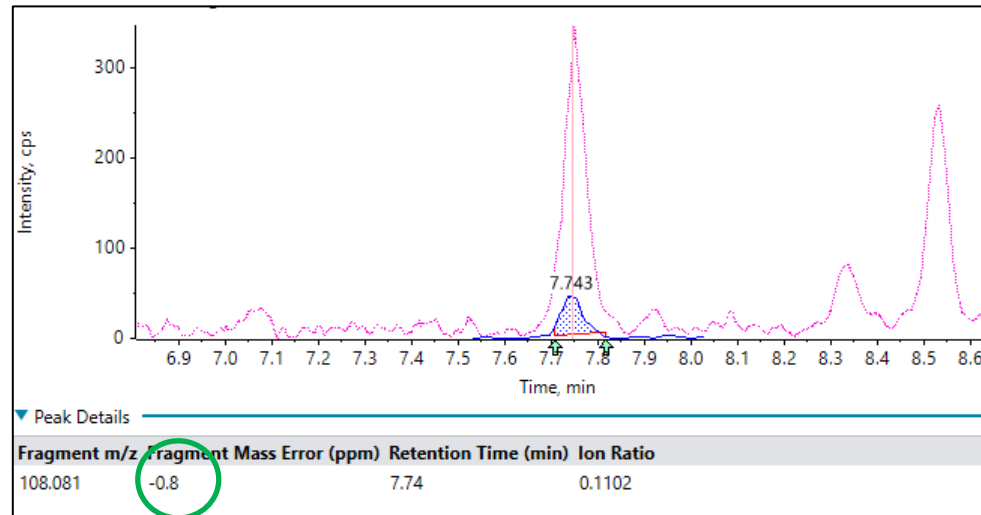
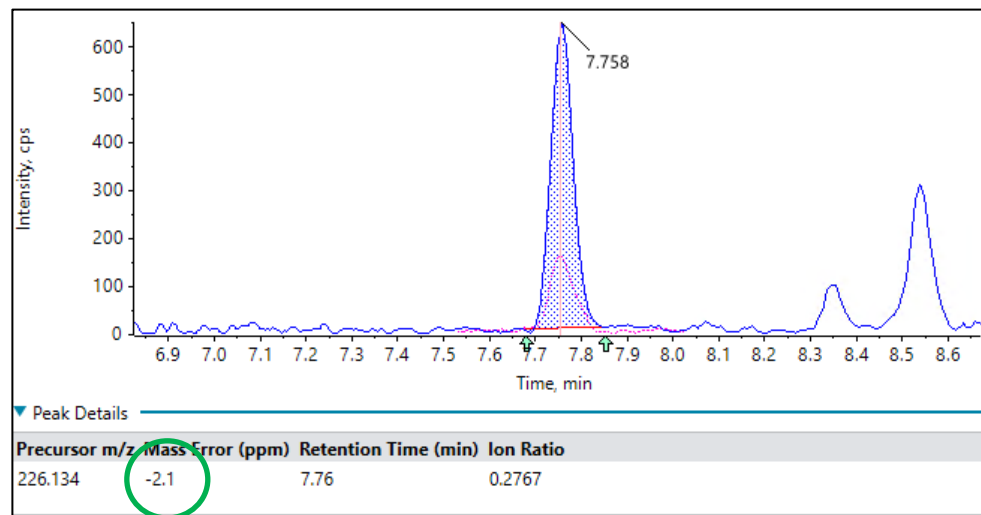



# Non-targeted screening: ZenoTOF (Zeno Trap Pulsing) using Information-dependent acquisition (IDA)

High-Resolution MS/MS Spectral Library (Pesticides: 557 compounds)

## Tentative Identification of Quinmerac

APIStrip sample

Index	Sample Name	Compo... Name	Compo... Group...	Area	Retention Time	Adduct / Charge	Formula	Precursor Mass	Library Hit	Library Score	Iso... Co...	Found At Mass	Mass Error (ppm)	Us	Fr... M...
4...	AT_5_2_R2...	609.2804...		2.884e4	13.61	[M+H] <sup>+</sup>	(608.2737...	609.280	Reserpine	95.9	■	609.2804	N/A	<input checked="" type="checkbox"/>	■
4...	AT_5_2_R2...	181.0833...		1.093e4	4.26	[M+H] <sup>+</sup>	(180.0766...	181.083	Theophylline	95.8	■	181.0837	N/A	<input checked="" type="checkbox"/>	■
4...	AT_5_2_R2...	146.0601...		1.607e5	4.47	[M+H] <sup>+</sup>	(145.0533...	146.060	8-Hydroxyquinoline	95.6	■	146.0602	N/A	<input checked="" type="checkbox"/>	■
4...	AT_5_2_R2...	222.0422...		2.287e3	5.57	[M+H] <sup>+</sup>	(221.0355...	222.042	Quinmerac	95.0	■	222.0316	N/A	<input checked="" type="checkbox"/>	■
4...	AT_5_2_R2...	122.0600...		1.096e4	4.39	[M+H] <sup>+</sup>	(121.0532...	122.060	2-Phenethylamine	92.7	■	122.0599	N/A	<input checked="" type="checkbox"/>	■

Molecular ion (Full Scan)

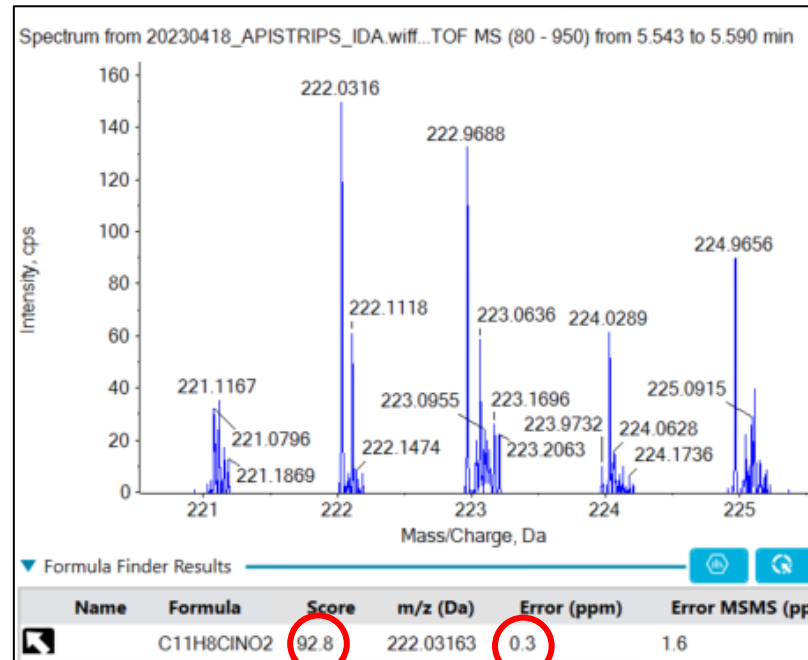

Score (Mass error and Isotope Pattern)

MS/MS Library Matching

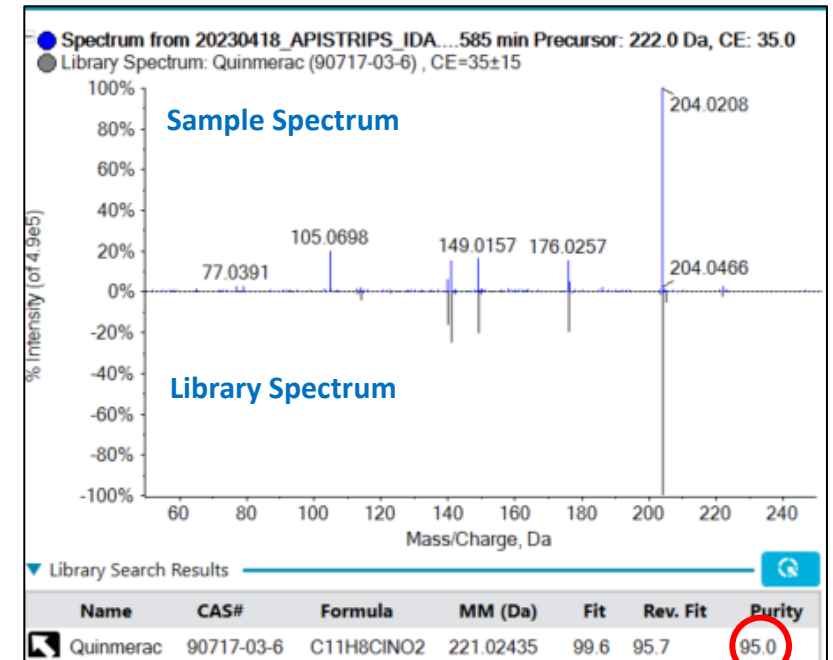

Herbicide  
Quinmerac

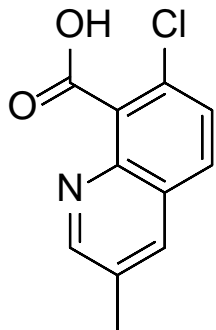

C<sub>11</sub>H<sub>8</sub>ClNO<sub>2</sub>  
m/z 222.03163

**Non-targeted screening: ZenoTOF (Zeno Trap Pulsing) using IDA acquisition and High-Resolution MS/MS Spectral Library  
(Pesticides: 557 compounds)**

**Tentative Identification of Quinmerac**

MS/MS Spectrum

Quinmerac  
 $C_{11}H_8ClNO_2$

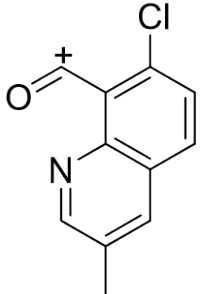
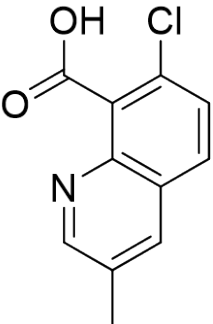

$C_{11}H_7ClNO^+$   
Mass error 1.4 ppm

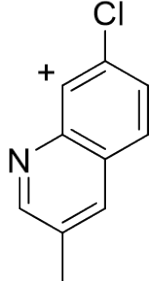

$C_{10}H_7ClN^+$   
Mass error 2.8 ppm

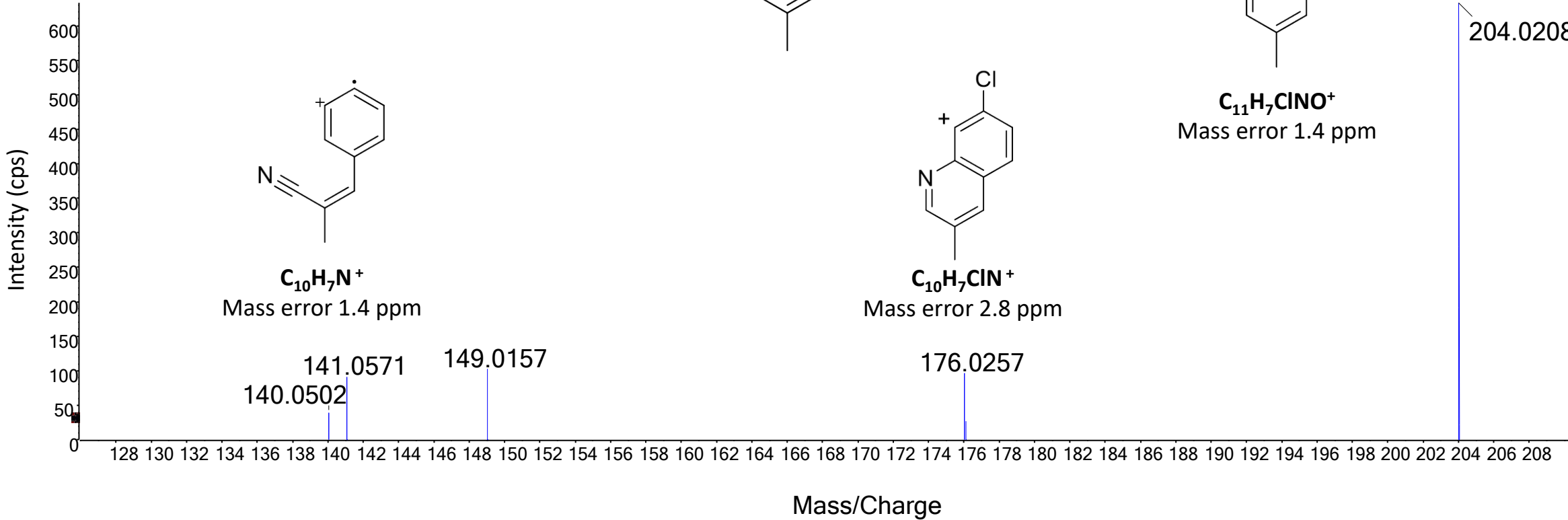

# CONCLUSIONS

QqQ

TOF

ORBITRAP

IMS

**CHROM.**

**CLEAN UP**







**Muchas gracias  
por la atencion**



**EUURL**  
EUROPEAN  
UNION  
REFERENCE  
LABORATORY

*amadeo@ual.es*